

TABLE OF CONTENTS

1. INTRODUCTION AND SYSTEM DESCRIPTION	5
2. ELECTRICAL CONNECTION.....	8
3. OVERVIEW OF OPERATION.....	8
3.1 TIME(S).....	8
3.2 CURRENT(S).....	8
3.3 VOLTAGE(S)	8
3.4 TEST MODE:	9
4. CONDENSED OPERATING INSTRUCTIONS.....	10
4.1 Constant Current Charge (normal mode)	10
4.2 Constant Voltage.....	11
4.3 Peak Voltage Charge	12
4.4 Peak Voltage Transfer	13
4.5 Discharge	13
4.6 BTAS Connection	14
See paragraph [7] for details on connection and operation with the BTAS16	14
5. SPECIFICATIONS	15
5.1 CHARGE.....	15
5.2 DISCHARGE	17
5.3 TIMER.....	18
5.4 LINE INPUT VOLTAGE:	18
5.5 DIGITAL PANEL METERS.....	20
5.6 FUSES and BREAKERS (Other than charge and discharge current limiters)	20
5.7 ENVIRONMENTAL	20
6. CONTROLS AND DISPLAYS.....	21
6.1 M1 - Ammeter	21
6.2 M1 - Voltmeter	21
6.3 R1 - Main Charge Current Selector	21
6.4 R2 - Topping/Discharge Current Selector	21
6.5 SW1 - Main Time selector switch	21
6.6 SW2 - Total Time selector switch	21
6.7 SW3 – Keypad.....	21
6.8 SW4 - CELL SELECTOR:	22
6.9 SW5 - DIGITAL VOLTMETER INPUT SELECTOR:	22

6.10	SW6 - VOLTAGE MODE SELECTOR:.....	22
6.11	SW7 - TIMER SPEED SELECTOR:	22
6.12	DS1A - RESET:.....	22
6.13	DS1B - CYC END:.....	22
6.14	DS2A - DUAL:	22
6.15	DS2B - MAIN:.....	22
6.16	DS3A - SINGLE:.....	22
6.17	DS3B - TOP:.....	22
6.18	DS4A - AUTO:	22
6.19	DS4B - DISCH:	22
6.20	DS5A - FULL:	22
6.21	DS5B - DISCH:	22
6.22	DS6A - CAP FAIL:	23
6.23	DS6B - OPEN LIM:.....	23
6.24	DS7A - OVR TEMP:	23
6.25	DS7B - OVR HEAT:.....	23
6.26	DS8A - VOLT FLT:.....	23
6.27	DS8B -CURR FLT:.....	23
6.28	DS9 - CC	23
6.29	DS10 - CV	23
6.30	DS11 – PEAK TRANSFER.....	23
6.31	DS11 – PEAK STOP	23
6.32	AUDIBLE ALARM:.....	24
6.33	STATUS LCD	24
7.	BTAS INTERFACING	24
7.1	Control.....	24
	The Control Connection allows the BTAS to monitor the status of the Charger-Analyzer and also to control the Start/Stop of the operation.	24
7.2	Shunt	24
	The Shunt Connection allows the C-Scan to measure and report the Charge/Discharge Current.....	24
8.	MODES OF OPERATION	26
8.1	CONSTANT CURRENT CHARGE	26
8.2	CONSTANT VOLTAGE CHARGE.....	27
8.3	PEAK CHARGE.....	27
8.4	DISCHARGE	28
9.	OPERATING INSTRUCTIONS	29
9.1	GENERAL	29
9.2	CONSTANT CURRENT CHARGE	30

9.3	CONSTANT VOLTAGE CHARGE.....	30
9.4	Peak Voltage Charge	31
9.5	Peak Voltage Transfer.....	32
9.6	Discharge	33
9.7	Float/Peak Voltage Chart.....	34
9.8	STATUS LCD	35
9.9	OPERATING NOTES AND PRECAUTIONS	37
9.10	Operation with the BTAS16.....	38
10.	INSTALLATION.....	38
10.1	BENCH SPACE	38
10.2	LINE VOLTAGE (mains).....	38
10.3	Fuses and limiters:	39
11.	VERIFICATION OF PERFORMANCE	40
11.1	REQUIRED TEST EQUIPMENT AND ACCESSORIES.....	40
11.2	VISUAL VERIFICATION	40
11.3	TIMER VERIFICATION.....	41
11.4	BATTERY OVERTEMP CUT-OFF	42
11.5	VOLTAGE FAULT TEST.....	42
11.6	REVERSE POLARITY TEST	43
11.7	OVERVOLTAGE CUT-OFF	43
11.8	DISCHARGE VOLTAGE CUT-OFF.....	43
11.9	FULL DISCHARGE	43
11.10	CURRENT TRACKING.....	44
11.11	VOLTAGE CONTROL	44
11.12	FLOAT VOLTAGE.....	45
11.13	PEAK VOLTAGE:.....	45
11.14	METERS	46
12.	CALIBRATION	47
12.1	CIRCUIT BOARD ADJUSTMENTS AND CALIBRATION	47
12.2	DIGITAL METERS (see [Figure 6]).....	47
13.	TROUBLESHOOTING AND REPAIRS.....	52
13.1	TROUBLESHOOTING	52
13.2	FINDING A SHORTED DISCHARGE TRANSISTOR.....	54
14.	INSTALLATION.....	58
14.1	BENCH SPACE	58
14.2	LINE VOLTAGE (mains).....	58
14.3	FUSES AND LIMITERS:	58

15. LINE VOLTAGE (MAINS)59

16. POWER BLOCK DIAGRAM61

17. REPLACEABLE MODULES AND PARTS62

 17.1 CIRCUIT BOARDS62

 17.2 PARTS62

 17.3 TEST EQUIPMENT62

 17.4 OTHER.....62

18. BATTERY TESTING NOTES.....63

19. GLOSSARY64

20. DISCLAIMER65

 20.1 Applicability65

 20.2 JFM Engineering’s responsibility65

 20.3 User’s Responsibility65

21. REVISION INDEX66

TABLE OF FIGURES

Figure 1 - Block Diagram 7

Figure 2 – 230V, 30A Receptacle..... 8

Figure 3 - Front Panel25

Figure 4 – Rear Panel25

Figure 5 – LCD Readout36

Figure 6 - Meters Board Adjustments (rear view)48

Figure 7 – Voltage/Current Control Board Adjustments49

Figure 8 - Measuring for a shorted transistor.....55

Figure 9 - Measuring for a shorted transistor.....56

Figure 10 - Location of Current Limiters57

Figure 11 – Chassis Line Voltage Input59

Figure 12 – Transformer Control Wiring59

Figure 13 - Line Voltage Wiring, left side.....60

Figure 14 - Line Voltage Wiring, right side60

Figure 15 – Power Diagram.....61

TABLE OF TABLES

Table 1 - Constant Voltage and Peak Voltage Chart34

Table 2 - Index of Revisions.....66

1. INTRODUCTION AND SYSTEM DESCRIPTION

This Charger-Analyzer is a precision instrument designed to charge and analyze NICKEL-CADMIUM, LEAD-ACID and other rechargeable batteries, as recommended by the battery manufacturers.

The simple to set controls plus the condensed operating procedure found on the front panel makes it a very easy to operate test instrument, which combined with easy to read CURRENT, VOLTAGE, TIME and STATUS indicators, makes it also a very simple one to monitor.

It is also designed for speed, for it can charge two batteries, (actually, any number of batteries where the total number of cells is 50 or less), at maximum currents, and it can also discharge two batteries at reduced currents, or one battery (25 cells or less) at maximum current (limited by power dissipation).

This Charger-Analyzer provides a Voltage Control enhancement that allows the Charger-Analyzer, originally designed for Constant Current operation on Nickel-Cadmium batteries to also be able to handle Lead-Acid and other type of rechargeable batteries, where the end voltage is a more reliable indicator of the state of charge.

Dependability is another great plus. 100% SOLID STATE circuitry requires no scheduled maintenance. No relay contacts to inspect and clean. No high current carrying contacts to arc and burn. A simple performance verification procedure is all it takes to determine if the instrument requires re-calibration or repair.

It is also protected against certain internal performance deviations and programming errors, plus it is also designed to sense certain battery abnormalities to protect the instrument and battery from possible damage. In the event that any malfunction takes place, VISUAL and AUDIBLE indicators will turn on, alerting the operator and preventing any further operation of the unit.

The Charger-Analyzer System is comprised of the Charger-Analyzer, the Temp-plate, the Battery Cable and the Single Cell adaptor.

It is basically a precision programmable constant current source (for charge) and a programmable constant current sink (for discharge) combined with voltage and temperature sensing circuits for total battery monitoring.

The specially designed circuitry provides a performance not achieved by any of the older conventional battery charging methods. It will deliver current into a short circuit or a battery or combination of batteries totaling 50 cells, within $\pm 1\%$ of the programmed value, independent of line voltage variations (within $\pm 10\%$ of the nominal line voltage).

The control circuitry of the Charger-Analyzer consists of a CONTROL PROCESSOR, a CLOCK TIMER, a VOLTAGE/CURRENT CONTROL, a VOLTMETER/AMMETER, a POWER CONTROL BOARD and a TRANSFORMERS CONTROL Board. See Figure 1

The CONTROL PROCESSOR receives the function commands from the various function selectors on the Front panel and outputs control signals to the rest of the circuit boards and ultimately to the Charge-Discharge Banks.

The TIMER displays the elapsed time for all of the test performed. Digital time and speed selectors provide the external inputs, while the four digit readout of the CLOCK provides the elapsed time display.

The VOLTAGE-CURRENT CONTROL Circuit Board interprets the programmed current values and controls the conduction of the SCR's and transistors to maintain a constant current in accordance to the feedback received from a precision shunt. It also provides the functions that regulate the charging current in the Constant Voltage (float) mode and in the Peak Voltage mode, transfers from Main to Topping charge on a voltage peak or ends charging on a voltage peak.

Display of current is provided by an independent Digital Ammeter that uses the same shunt used by the VOLTAGE/CURRENT CONTROL circuit.

Inputs from the TIMER and the CONTROL PROCESSOR determine the operating mode of the CURRENT CONTROL circuit.

The SYSTEM MONITOR within the CONTROL PROCESSOR provides several safeguarding functions. It compares the measured current against the programmed value and if they differ beyond what the software allows, operation is halted and a current malfunction is indicated.

It measures the battery voltage and compares it with the programmed number of cells. From there, it determines during charge if the total voltage exceeds the equivalent of 1.75 V per cell, indicating an Overvoltage condition, or during discharge if the total voltage is below the equivalent of 1 volt per cell, indicating the end of the discharge cycle.

It checks for polarity reversal at voltages as low as 0.25V, as well as an absolute Overvoltage at about 42V/85V, both generating a voltage malfunction indication that prevents any further operation of the unit.

It measures the temperature of the discharge heat dissipators and signals an overheat malfunction if the internal temperature exceeds 90°C, as it could be caused by a fan failure or an installation with restricted air flow. It also monitors the temperature of the batteries being charged (via the TEMP-PLATE) and terminates the charge, indicating battery Overtemp, in the event of battery overheating that may lead to thermal runaway.

The DIGITAL VOLTMETER provides internal battery voltage readings with resolutions of 0.1V and 0.01V, while a selectable external position allows single cell measurements to a resolution of 0.001V.

Additional protection is provided by a high speed current limiter for the discharge transistor bank, a slow speed current limiter for the charge circuit and a magnetic circuit breaker capable of tripping under fast high current overload conditions.

The Charger-Analyzer is also equipped to communicate and be controlled by the BTAS16, Computerized Battery Test System.

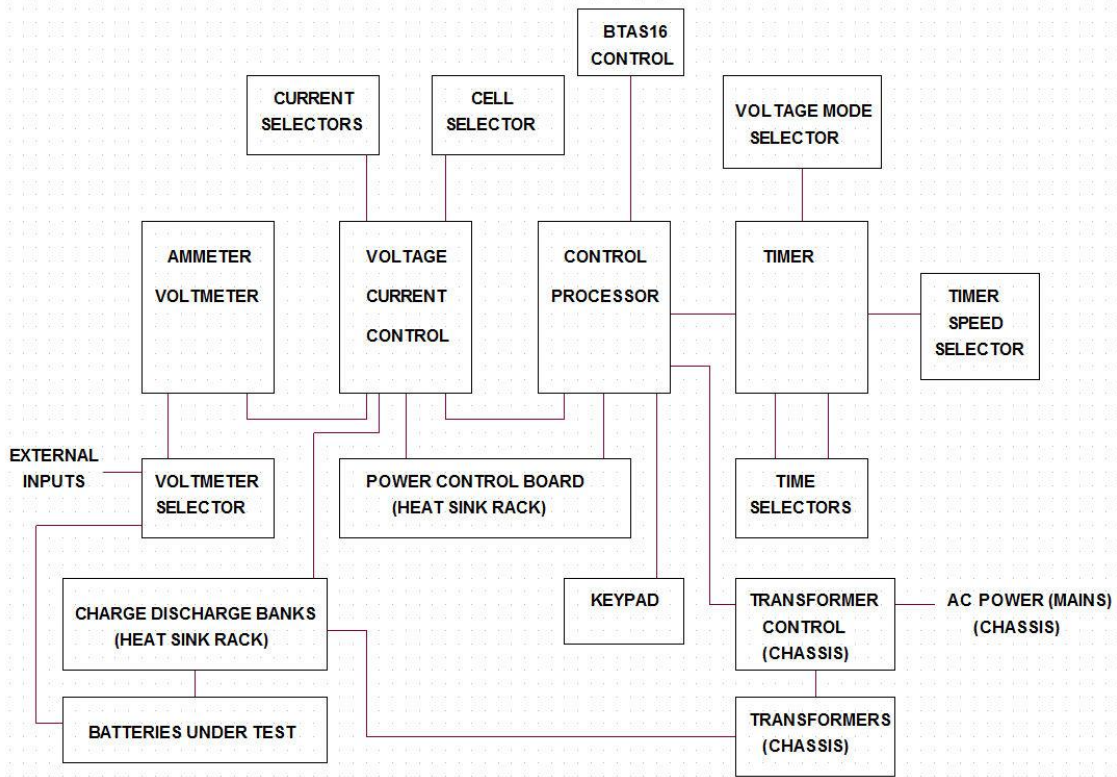

Figure 1 - Block Diagram

2. ELECTRICAL CONNECTION

Connect directly (not shared) to a source of 208V, 230V or 240VAC, 50-60Hz with a 30A capacity receptacle (NEMA 6-30R or equivalent), and provide a circuit breaker rated at 30A preferably of the motor load type (high inrush capable).



Figure 2 – 230V, 30A Receptacle

3. OVERVIEW OF OPERATION

To use the Charger-Analyzer to perform tests on a battery, the following parameters must be selected in accordance with the requirements as stipulated in the Battery CMM, OMM or Manual:

3.1 TIME(S)

- 3.1.1. Select the time duration (or durations)
- Time for Single Rate Charge modes (Constant Current and Constant Voltage).
 - Times for Dual Rate Charge modes (Main and Topping Charge)
 - Time for Capacity test or Time for Full Discharge

3.2 CURRENT(S)

- 3.2.1. Select the Charge Current (or Currents)
- Current for Single Rate Charge modes. Constant Current or Constant Voltage Charge.
 - Currents for Dual Rate (Main and Topping Charge)
- 3.2.2. Select the Discharge Current
- Discharge Current for Capacity Test or Discharge Current for Full Discharge.

3.3 VOLTAGE(S)

- 3.3.1. Select the Charge Voltage limit by way of the Cell Selector. See Chart in [9.7].
- Voltage for Single Rate modes. CV Charge Voltage, Peak Voltage for charge ending, or Overvoltage in CC.
 - Voltages for Dual Rate transfer (Main and Topping Charge) in Peak Voltage for Transfer or Overvoltage in CC).
- 3.3.2. Select the Discharge Voltage limit by way of the Cell Selector
- Discharge Voltage for Capacity Test. In CC, 1V/cell

- *Note: Voltage not used in Full Discharge.*

3.4 TEST MODE:

- 3.4.1. Select the Test Mode to define what the equipment needs to do to the battery
- Single Rate Charge, Dual Rate Charge
 - Single Rate Constant Voltage Charge or Peak Charge by using the Voltage Mode Selector.
 - Capacity Test, Full Discharge.

4. CONDENSED OPERATING INSTRUCTIONS

CAUTION: Disconnect power and batteries before performing any internal maintenance. Failure to observe this caution may result in serious damage to the unit and injury to the operator.

NOTE: The current selector potentiometers display three digits indicating XX.X AMPS. e.g.: in order to select 4A dial 040 (04.0A), and for 20A dial 200 (20.0A).

4.1 Constant Current Charge (normal mode)

4.1.1 Voltage Mode

- 4.1.1.1 Select CC for Dual Rate or Single Rate

4.1.2 Number of Cells

- 4.1.2.1 Enter the number of cells
- 4.1.2.2 *NOTE: when charging more than one battery enter the total number of cells.*

4.1.3 Main Charge Time

- 4.1.3.1 Enter the MAIN CHARGE TIME and TOTAL TIME if in the TWO RATE mode, or enter the TOTAL CHARGE TIME only if in the SINGLE RATE mode.

Note: Total Time equals Main Time plus Topping Time

- 4.1.3.2 Verify that the Timer Speed is consistent with the required elapsed time (hours or minutes).

- 4.1.3.3 Enter the MAIN and TOPPING CHARGE CURRENTS, if in the TWO RATE mode, or enter the TOPPING CURRENT only if in the SINGLE RATE mode.

Note 1: For currents under 1A, select 1A and adjust to the required current after it starts.

Note 2: Selecting currents above the 50A maximum will generate an error message.

- 4.1.3.4 Place batteries on the TEMP-PLATE and connect the small cable to the TEMP-PLATE (the red "BATTERY OVERTEMP" INDICATOR will be on if not connected).

- 4.1.3.5 Note that when working with only one battery, the unused plug must be connected into the shorted receptacle provided in the TEMP-PLATE. Note that a Voltage Fault will be generated if attempting to charge with the free plug not shorted.

- 4.1.3.6 Depress the CONTROL BUTTON corresponding to the desired mode (white for TWO RATE and yellow for SINGLE RATE).

- 4.1.3.7 The charge will terminate automatically (CYCLE END) when the TOTAL TIME selected is reached.

- 4.1.3.8 The charge will also terminate as a FAULT if the PROCESSOR detects that:

- Battery temperature exceeds 40°C/104°F (BATTERY OVERTEMP FAULT).

- The total Battery voltage exceeds the equivalent of 1.75V/cell (VOLTAGE FAULT).
- The actual charge current deviates from the programmed value (CURRENT FAULT).

4.2 Constant Voltage

4.2.1 Voltage Mode

4.2.1.1 Select CV for Constant Voltage Charging

4.2.2 Battery Voltage

4.2.2.1. Enter the nominal battery voltage using the cell selector (see the chart on section [9.7]).

4.2.2.2. Program the maximum charge current in the Topping Current Selector. Disregard the Main Current Selector.

4.2.2.3. Program sufficient time in the Total Time Selector (disregard the Main Time Selector) to allow the battery to reach the required charge under constant voltage charge (consult battery manufacturers specifications). Verify that the Timer Speed is consistent with the required elapsed time (hours or minutes).

4.2.2.4. Start the Charger-Analyzer in the Single Rate mode. The current will rise to the selected value and the control circuitry will begin to reduce the charging current when the battery voltage is within 0.5V of the float level.

4.2.2.5. The charge will terminate automatically (CYCLE END) when the TOTAL TIME selected is reached.

4.2.2.6. The charge will also terminate as a FAULT if the PROCESSOR detects that:

- Battery temperature exceeds 40°C/104°F (BATTERY OVERTEMP FAULT).
- The actual charge current is higher than the programmed value (CURRENT FAULT) once it is in the CV mode.
- The battery voltage is higher than what is selected by the Cell Selector.

4.3 Peak Voltage Charge

4.3.1. Voltage Mode

4.3.1.1. Select PEAK STOP to stop the charge at the selected peak voltage.

4.3.2. Nominal Battery Voltage

4.3.2.1. Enter the nominal battery voltage using the cell selector (see the chart on section [9.7]).

4.3.2.2. Select transfer from Main to Topping on Peak (PEAK TRANSFER) or stop on Peak (PEAK STOP).

4.3.2.3. Program the Topping Charge currents as required.

4.3.2.4. Program the Total Time selector to allow the battery to reach the required charge level (consult battery manufacturers specifications). Verify that the Timer Speed is consistent with the required elapsed time.

4.3.2.5. Start the Charger-Analyzer in the Single Rate mode. The charger will stop when the battery reaches the peak voltage.

4.3.2.6. The charge will terminate automatically (CYCLE END) when the TOTAL TIME selected is reached.

4.3.2.7. The charge will also terminate as a FAULT if the Processor detects that:

- Battery temperature exceeds 40°C/104°F (BATTERY OVERTEMP FAULT).
- The actual charge current deviates from the programmed value (CURRENT FAULT).

4.4 Peak Voltage Transfer

4.4.1. Voltage Mode

- 4.4.1.1. Select PEAK XFR to transfer from Main to Topping at the selected peak voltage.

4.4.2. Nominal Battery Voltage

- 4.4.2.1. Enter the nominal battery voltage using the cell selector (see the chart on section [9.7]).
- 4.4.2.2. Program the Main and Topping Charge currents as required.
- 4.4.2.3. Program the Main and Total Time selector to allow the battery to reach the required charge level (consult specifications from the manufacturers of the batteries). Verify that the Timer Speed is consistent with the required elapsed time.
- 4.4.2.4. Start the Charger-Analyzer in the Dual Rate mode. The charger will transfer from Main to Topping if the selected voltage is reached or if the time has been reached, whichever comes first.
- 4.4.2.5. The charge will terminate automatically (CYCLE END) when the TOTAL TIME selected is reached.
- 4.4.2.6. The charge will terminate as a FAULT if the PROCESSOR detects that:
 - Battery temperature exceeds 40°C/104°F (BATTERY OVERTEMP FAULT).
 - The actual charge current deviates from the programmed value (CURRENT FAULT).

4.5 Discharge

NOTE : Do not place batteries on the Temp-Plate during discharge. Due to the normal heating of the battery a false Overtemp may be generated later during the charge process.

4.5.1. Voltage Mode

- 4.5.1.1. Select CC for AUTO DISCHARGE OR FULL DISCHARGE.
Note: Attempting to discharge in other than CC VOLTAGE MODE will generate an error.

4.5.2. Number of Cells

- 4.5.2.1. Enter the number of cells.
- 4.5.2.2. The capacity test threshold will equal one volt for each cell selected (20 cells equals 20V).
- 4.5.2.3. Ignore this step if FULL DISCHARGE is to be selected.

4.5.3. Total Time

- 4.5.3.1. Enter the TOTAL TIME (ignore the Main Time).
- 4.5.3.2. Verify that the Timer Speed is consistent with the required elapsed time.
- 4.5.3.3. Enter the DISCHARGE CURRENT (ignore the Main Current).
Note 1: For current under 1A, select 1A and adjust to the required current after it starts.
Note 2: Selecting current above the 60A maximum will generate an error message.
- 4.5.3.4. Depress the Blue button for DISCHARGE with automatic cut-off (ANALYSIS), or the Red button for FULL DISCHARGE.
- 4.5.3.5. DISCHARGE will terminate automatically (CYCLE END) when the (TOTAL) time selected is reached or (CAPACITY FAILURE) if the BATTERY voltage falls below the equivalent of ONE VOLT per CELL prior to the selected time.
- 4.5.3.6. NOTE: Battery voltage is ignored during Full Discharge.
- 4.5.3.7. Discharge will terminate as a FAULT if the PROCESSOR detects:
 - An overheating of the discharge transistors (OVERHEAT FAULT).
 - That the discharge current differs from the programmed value (CURRENT FAULT).
 - That the programmed current exceeds 30A for a battery voltage in excess of 32V.

4.6 BTAS Connection

See paragraph [7] for details on connection and operation with the BTAS16

5. SPECIFICATIONS

5.1 CHARGE

5.1.1. CONTROL: SCR, air cooled.

5.1.2. MAXIMUM CURRENT: 50 AMPS.

Note: when charging a Single Cell, the current is limited to 25A

5.1.3. MINIMUM INCREMENT: 0.1 AMP.

5.1.4. ACCURACY and STABILITY of settings: $\pm 1\%$ of reading, ± 0.1 AMP.

5.1.4.1. CV (FLOAT):

- The reference voltage is set at the equivalent of 2.33V/cell (Lead-Acid).
- The Cell Selector provides the basic reference as nominal battery voltage, e.g.: a 24V battery is entered as 24 on the Cell Selector. See the chart on section [9.7].
- Current reduction takes place from within 0.5V of the float voltage, with an accuracy of $\pm 0.5\%$, $\pm 0.1A$

5.1.4.2. PEAK:

- The reference voltage is set at the equivalent of 2.45V/cell (Lead-Acid).
- The Cell Selector provides the basic reference as nominal battery voltage, e.g.: a 24V battery is entered as 24 on the Cell Selector. See the chart on section [9.7].
- Voltage transfer or stop within 1% of the Peak Voltage.
- Note: Due to cable/connector losses the peak voltage registered by the Charger-Analyzer will be higher than the actual battery voltage (up to 0.2V depending on current).

5.1.5. TEST MODES:

5.1.5.1. Main and Topping for Constant Current

5.1.5.2. Constant Voltage

5.1.5.3. Peak Transfer (transfer from Main to Topping on a peak voltage)

5.1.5.4. Peak Voltage Stop (stop the charge on a peak voltage).

5.1.6. TIMER:

5.1.6.1. 1 to 9 hours for MAIN charge time and 1 to 59 hours for TOTAL time.

5.1.6.2. Time can also be programmed in minutes by selecting the FAST mode in the TIMER SPEED selector switch (Front Panel).

5.1.6.3. NOTE: Topping charge time equals the total charge time minus the main charge time (TOTAL = MAIN + TOP).

- 5.1.7. TEST MODES:
 - 5.1.7.1. Main and Topping for Constant Current
 - 5.1.7.2. Constant Voltage
 - 5.1.7.3. Peak Transfer (transfer from Main to Topping on a peak voltage)
 - 5.1.7.4. Peak Voltage Stop (stop the charge on a peak voltage).
- 5.1.8. TIMER:
 - 5.1.8.1. 1 to 9 hours for MAIN charge time and 1 to 59 hours for TOTAL time.
 - 5.1.8.2. Time can also be programmed in minutes by selecting the FAST mode in the TIMER SPEED selector switch (Front Panel).
 - 5.1.8.3. NOTE: Topping charge time equals the total charge time minus the main charge time (TOTAL = MAIN + TOP).
- 5.1.9. OVERTEMP PROTECTION:
 - 5.1.9.1. Four thermistors on the TEMP-PLATE measure the battery case (bottom) temperature.
 - 5.1.9.2. The charge is terminated when the surface temperature of the TEMP-PLATE reaches 40°C (104°F).
- 5.1.10. OVER/UNDER CURRENT PROTECTION:
 - 5.1.10.1. The Processor continuously compares the actual charge current with the programmed value.
 - 5.1.10.2. Operation is terminated if they differ.
- 5.1.11. OVERVOLTAGE PROTECTION:
 - 5.1.11.1. Programmable, in accordance with the number of cells selected, at the equivalent of 1.75 volts/cell (TOLERANCE: ±1%, ±0.1V).
 - 5.1.11.2. Absolute maximum internal limit set at 85 VOLTS.
 - 5.1.11.3. NOTE: Does not apply in the CV and Peak voltage modes. (Voltage is separately controlled in those modes).
- 5.1.12. REVERSE POLARITY PROTECTION:
 - 5.1.12.1. Operation of the unit is inhibited for reverse voltages greater than 0.25 VOLTS.
- 5.1.13. FUSING:
 - 5.1.13.1. Aircraft type current limiter, ANL-60 (slow) for charge and ANN-80 (fast) for discharge.
 - 5.1.13.2. 240V, 40A circuit breaker
- 5.1.14. AC LINE CURRENT:
 - 5.1.14.1. Idling: 0.2A @N1, .2A @ N2
 - 5.1.14.2. Running:
 - @N1: 0.2 of the charging current (5A AC @ 25A DC)
 - @N2: 0.4 of the charging current (10.5A AC @ 25A DC)
 - 5.1.14.3. *Note: nominal values, line voltage and frequency dependent.*

5.2 DISCHARGE

- 5.2.1. CONTROL: Transistors, air cooled.
- 5.2.2. MAXIMUM CURRENT:
 - 5.2.2.1. 60 AMPS. Total power dissipation must not exceed 1.5KW (1500 watts, the product of battery voltage and battery current).
 - 5.2.2.2. NOTE: Discharge current is automatically limited to 30 AMPS for battery voltages in excess of 26.4 VOLTS. A current fault will be generated if attempting to discharge at more than 30 AMPS.
- 5.2.3. MINIMUM INCREMENT:
 - 5.2.3.1. 0.1 AMP.
- 5.2.4. ACCURACY and STABILITY of settings:
 - 5.2.4.1. $\pm 1\%$ of reading, ± 0.1 AMP.
- 5.2.5. TEST MODES:
 - 5.2.5.1. Analysis (automatic cut-off)
 - 5.2.5.2. Full discharge (no voltage limit).
- 5.2.6. TERMINAL VOLTAGE:
 - 5.2.6.1. Programmable, in accordance with the number of cells selected, at the equivalent of 1 VOLT/cell.
 - 5.2.6.2. TOLERANCE: $\pm 1\% \pm 0.1$ VOLT.
 - 5.2.6.3. NOTE 1: Due to cable/connector losses the voltage registered by the Charger-Analyzer will be lower than the actual battery voltage (up to 0.2V depending on current).
 - 5.2.6.4. NOTE 2: Terminal voltage is ignored in the full discharge mode.
- 5.2.7. OVERHEAT PROTECTION:
 - 5.2.7.1. Two thermistors measure the temperature of each of the two banks of discharge transistors.
 - 5.2.7.2. Operation is terminated if the transistors surface temperature exceeds 90°C .
 - 5.2.7.3. Smart fans turn on at about 32°C (89.6°F) and ramp up their speed as the temperature rises.
- 5.2.8. OVER/UNDER CURRENT PROTECTION:
 - 5.2.8.1. The Processor continuously compares the actual charge current with the programmed value.
 - 5.2.8.2. Operation is terminated if they differ.
 - 5.2.8.3. NOTE: Undercurrent monitoring is disabled in the full discharge mode for battery voltages below 3.0V.
- 5.2.9. REVERSE POLARITY PROTECTION:
 - 5.2.9.1. Operation of the unit is inhibited for reverse voltages greater than 0.25V
- 5.2.10. FUSING:

5.2.10.1. Aircraft type current limiter, ANN-80(fast).

5.2.10.2. *NOTE: The type of limiter and current rating are critical for proper protection of the discharge circuits. Failure to replace the discharge current limiter with the proper type/value may result in catastrophic damage of the load banks.*

5.3 TIMER

5.3.1. TIME BASE:

5.3.1.1. Timing is provided by the Control Processor.

5.3.2. MODES:

5.3.2.1. NORMAL: Timer advances at the rate of one count per minute (HH:MM).

5.3.2.2. FAST: Timer advances at the rate of one count per second (MM:SS).

5.3.2.3. TEST: Timer advances at the rate of 60 counts per second (SS:SS/60).

5.3.2.4. NOTE: The colon flashes at the rate of one cycle per second regardless of the selected mode.

5.3.3. ACCURACY AND STABILITY:

5.3.3.1. $\pm 0.1\%$

5.3.4. POWER FAILURE PROTECTION:

5.3.4.1. An internal rechargeable battery maintains (for several hours) the clock and other vital circuits for a dependable resumption of operation after a power failure.

5.3.4.2. The colon will be lit in case of a power failure.

5.3.4.3. NOTE: Do not operate the Charger-Analyzer without this battery or with a battery in bad condition. Replace only with the same type, 7 cells, rechargeable, 700mA-Hr minimum, Nickel-Cadmium or Nickel-Metal Hydride.

5.3.5. TIME LIMITS:

5.3.5.1. 0 to 9 in Main

5.3.5.2. 0 to 59 in Total

5.4 LINE INPUT VOLTAGE:

5.4.1. 208V, 230V, 245V

Note: For proper operation of this instrument, power line voltages must be within $\pm 10\%$ of the nominal.

- 5.4.2. The instrument is normally wired for 230V operation.
- 5.4.3. A terminal block at the transformer inputs allows field re-wiring for 208V or 245V
- 5.4.4. For operation at line voltages in excess of 240V at 50Hz, use the 245V.
- 5.4.5. See [Figure 13] and [Figure 14] for changing the line voltage

5.5 DIGITAL PANEL METERS

5.5.1. VOLTMETER:

- 5.5.1.1. Accuracy (system): $\pm 0.25\%$ of reading, $\pm 0.1\text{V}$ in the 200V scale, $\pm 0.01\text{V}$ in the 20V scale, $\pm 0.005\text{V}$ in the 2V scale.
- 5.5.1.2. Input impedance: 1 M-OHM.
- 5.5.1.3. Scale 2V, 20V and 200V (1.999V, 19.9V and 199.9V) for external measurements and 20V and 200V for internal (battery) measurements.

5.5.2. AMMETER:

- 5.5.2.1. Accuracy (system): $\pm 0.5\%$ of reading, $\pm 0.1\text{A}$
- 5.5.2.2. Scale: 200A (199.9A)

5.5.3. SHUNT:

- 5.5.3.1. Accuracy: $\pm 0.25\%$
- 5.5.3.2. Output: 1mV/A (100mV / 100A)

5.6 FUSES and BREAKERS (Other than charge and discharge current limiters)

- 5.6.1. Mains: Dual Magnetic Circuit Breaker, 40A
- 5.6.2. Power Supplies have their own protective fuse (4A)

5.7 ENVIRONMENTAL

5.7.1. Ambient Temperature:

- 5.7.1.1. 5°C to 35°C (41°F to 95°F)

Note: For best performance at high temperatures, limit the total dissipation at discharge to 1KW (discharge current x battery voltage) and use a small fan to remove any accumulation of hot air.

5.7.2. Relative Humidity:

- 5.7.2.1. 95%, non condensing
- 5.7.2.2. Note: High ambient humidity can lead to corrosion of contacts and other parts.

5.7.3. Altitude:

- 5.7.3.1. N/A

6. CONTROLS AND DISPLAYS

6.1 M1 - Ammeter

- 6.1.1. 0 to 199.9ADC DIGITAL PANEL METER.
- 6.1.2. Positive sign indicates charge current.
- 6.1.3. Minus sign indicates discharge current.

6.2 M1 - Voltmeter

- 6.2.1. 0 to 1.999VDC, 0 to 19.99VDC and 0 to 199.9VDC DIGITAL PANEL METER.
- 6.2.2. Indicates battery voltage in the internal (20/200V) position and voltage present at the RED (+) and BLK (-) jacks in the 2/20/200V external positions. Positive sign indicates proper battery connection. Minus sign indicates reversed polarity connection.

6.3 R1 - Main Charge Current Selector

- 6.3.1. Ten turn potentiometer with digital readout to select current
 - 6.3.1.1. MAIN charge current, 0 to 50.0 AMPS.

6.4 R2 - Topping/Discharge Current Selector

- 6.4.1. Ten turn potentiometer with digital readout to select current:
 - 6.4.1.1. TOPPING charge current, 0 to 50.0 AMPS
 - 6.4.1.2. DISCHARGE current, 0 to 60.0 AMPS

6.5 SW1 - Main Time selector switch

- 6.5.1. 0 to 9 hours (or minutes), to determine the duration of the main charge.

6.6 SW2 - Total Time selector switch

- 6.6.1. 0 to 59 hours (or minutes), to determine the total charge or discharge duration.

6.7 SW3 – Keypad

- 6.7.1. Five station membrane push button control switch to select and control the mode of operation, as follows:
 - 6.7.1.1. GREEN: Stop/Reset/End.
 - 6.7.1.2. WHITE: Two rate charge mode (main and topping).
 - 6.7.1.3. YELLOW: Single rate charge mode.
 - 6.7.1.4. BLUE: Auto cut-off discharge (analysis).
 - 6.7.1.5. RED: Full discharge.

6.8 SW4 - CELL SELECTOR:

- 6.8.1. Two digit selector to program the battery terminal voltage as a function of the number of cells.
- 6.8.2. Rate: 1.75 volts per cell for charge overvoltage and 1.0 volts per cell for discharge.
- 6.8.3. Used also in the Float and Peak Voltage modes to enter nominal battery voltage. See the chart in [Table 1] (page [34]).

6.9 SW5 - DIGITAL VOLTMETER INPUT SELECTOR:

- 6.9.1. External, 2/20/200V scale.
- 6.9.2. Internal, 20/200V scale.

6.10 SW6 - VOLTAGE MODE SELECTOR:

- 6.10.1. Four position switch to select Normal, Float and Peak Voltage modes.

6.11 SW7 - TIMER SPEED SELECTOR:

- 6.11.1. Three position switch to select
 - 6.11.1.1. Normal (HH:MM)
 - 6.11.1.2. FAST (MM:SS)
 - 6.11.1.3. TEST (SS:S/60).

6.12 DS1A - RESET:

- 6.12.1. Indicates that the unit is in standby.

6.13 DS1B - CYC END:

- 6.13.1. Flashing (with pulsating beeper) cycle end. Indicates that the unit has completed its cycle.

6.14 DS2A - DUAL:

- 6.14.1. Indicates that the DUAL rate mode (MAIN and TOPPING) is selected.

6.15 DS2B - MAIN:

- 6.15.1. Indicates that the unit is in MAIN charge.

6.16 DS3A - SINGLE:

- 6.16.1. Indicates that the SINGLE rate mode (Topping) is selected.

6.17 DS3B - TOP:

- 6.17.1. Indicates that the unit is in TOPPING charge.

6.18 DS4A - AUTO:

- 6.18.1. Indicates that the AUTO (analysis) mode is selected.

6.19 DS4B - DISCH:

- 6.19.1. Indicates that the unit is in AUTO discharge.

6.20 DS5A - FULL:

- 6.20.1. Indicates that the FULL discharge mode is selected.

6.21 DS5B - DISCH:

- 6.21.1. Indicates that the unit is in FULL discharge.

6.22 DS6A - CAP FAIL:

6.22.1. Indicates that the battery has failed to meet capacity.

6.23 DS6B - OPEN LIM:

6.23.1. Indicates that either the charge or discharge limiters are open.

6.24 DS7A - OVR TEMP:

6.24.1. Indicates Overtemp fault.

6.24.2. Continuous (no beeper): Indicates that the TEMP-PLATE is not connected (or open).

6.24.3. Flashing: Indicates battery temperature in excess of 40°C (at the Temp-Plate).

6.25 DS7B - OVR HEAT:

6.25.1. Indicates that the discharge bank is overheated.

6.26 DS8A - VOLT FLT:

6.26.1. Indicates voltage fault.

6.26.1.1. Continuous: battery connected with polarity reversed.

6.26.1.2. Flashing: (during charge) battery voltage in excess of 1.75 volts per cell or in excess of 42/85 volts, or open circuit.

6.27 DS8B -CURR FLT:

6.27.1. Indicates that the actual current differs from the selected value

6.28 DS9 - CC

6.28.1. Indicates that the charger is in the basic Constant Current mode.

6.29 DS10 - CV

6.29.1. Indicates that the charger is in the Constant Voltage mode.

6.30 DS11 – PEAK TRANSFER

6.30.1. Indicates that the charger is in the Constant Current/Transfer on Peak mode.

6.31 DS11 – PEAK STOP

6.31.1. Indicates that the charger is in the Constant Current/Stop on Peak mode.

6.32 AUDIBLE ALARM:

- 6.32.1. Continuous: turns on with any of the faults.
- 6.32.2. Pulsating: turns on with Cycle End.

6.33 STATUS LCD

The internal LCD Display will show error messages and some status information. (It is located behind the Timer).

- 6.33.1. The first and second lines will show basic status information while the second line will show error messages.
 - 6.33.1.1. First Line:
 - V: Program Version
 - C: Number of Cells
 - M: Running Mode
 - 6.33.1.2. Second Line:
 - B: Backup Battery Voltage
 - CV: AC Charge Voltage
 - T: Start-up delay time

7. BTAS INTERFACING

The Charger-Analyzer is equipped with connections for the BTAS16 Computerized Battery Test System. See [Figure 4].

7.1 Control

The Control Connection allows the BTAS to monitor the status of the Charger-Analyzer and also to control the Start/Stop of the operation.

7.2 Shunt

The Shunt Connection allows the C-Scan to measure and report the Charge/Discharge Current.

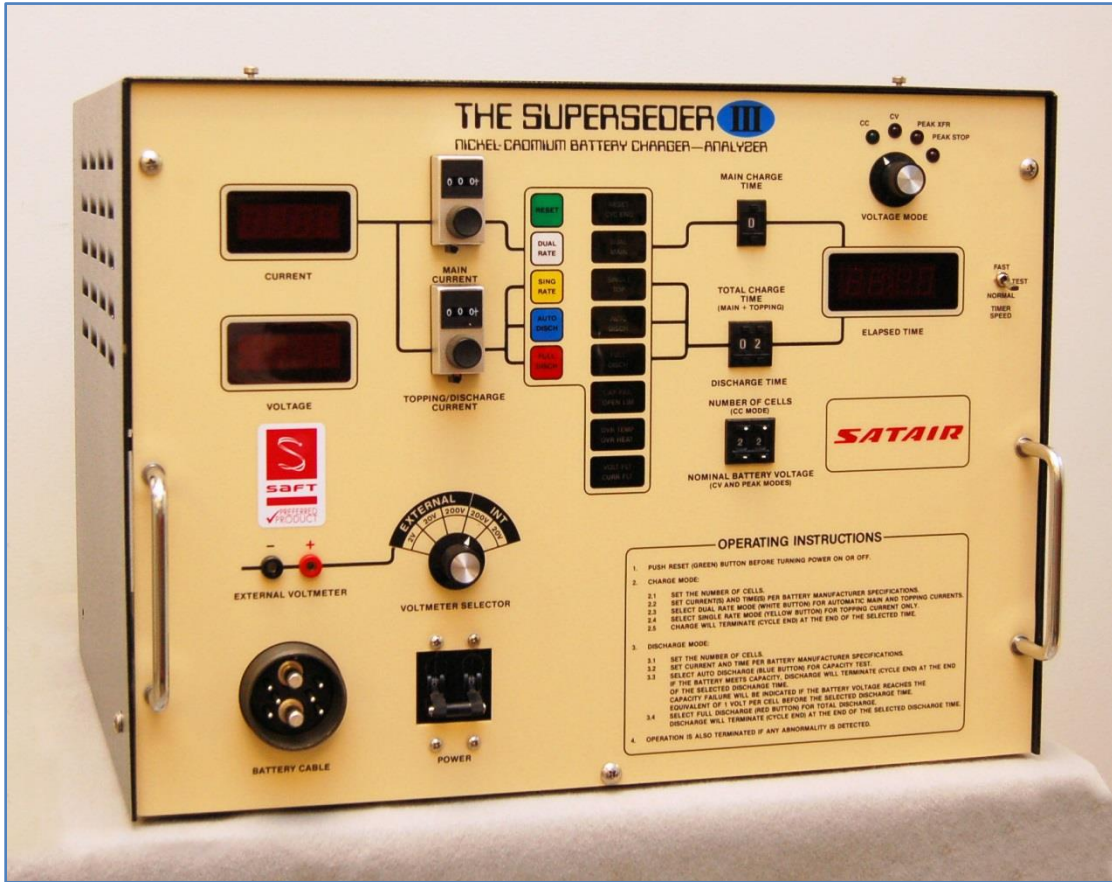

Figure 3 - Front Panel



Figure 4 – Rear Panel

8. MODES OF OPERATION

8.1 CONSTANT CURRENT CHARGE

8.1.1. DUAL RATE:

- 8.1.1.1. The battery is charged at the Main rate for a preset time, at the end of which, the current is switched automatically to the Topping rate for the remainder of the Total time selected.
- 8.1.1.2. Charging is automatically terminated at the end of the total time selected (cycle end), or as a fault if:
- Battery overtemperature is detected (Overtemp fault).
 - Battery voltage is in excess of 1.75V/cell as determined by the number of cells programmed, or if the battery voltage is in excess of 42/85V (voltage fault).
 - Actual charging current differs from the programmed value (current fault).
- 8.1.1.3. Charge operation may be terminated at any time by depressing the RESET (green) button.

8.1.2. SINGLE RATE:

- 8.1.2.1. The battery is charged at the Topping rate for a preset time.
- 8.1.2.2. Charging is automatically terminated at the end of the total time selected (cycle end), or as a fault if:
- Battery overtemperature is detected (Overtemp fault).
 - Battery voltage is in excess of 1.75V/cell as determined by the number of cells programmed, or if battery voltage is in excess of 42/85V (voltage fault).
 - Actual charging current differs from the programmed value (current fault).
- 8.1.2.3. Charge operation may be terminated at any time by depressing the (green) reset button.

8.2 CONSTANT VOLTAGE CHARGE

- 8.2.1. The battery is charged at the topping rate for a preset time.
- 8.2.2. When the battery voltage is within 0.5V of the selected float voltage, the charging current begins to diminish, and settles to the level of current required to maintain the battery at the selected float voltage.
- 8.2.3. Charging is automatically terminated at the end of the total time selected (cycle end), or as a fault if:
 - Battery overtemperature is detected (Overtemp fault).
 - Battery voltage is in excess of 42/85V (voltage fault).
 - Actual charging current differs from the selected value (current fault). Note: applicable only before the charger switches from constant current to constant voltage.
- 8.2.4. Charge operation may be terminated at any time by depressing the (green) reset button.

8.3 PEAK CHARGE

- 8.3.1. Transfer from Main to Topping on Peak voltage.
 - 8.3.1.1. The battery is charged at the main rate for a preset time.
 - 8.3.1.2. When the battery voltage reaches the programmed peak voltage, the charging current transfers from main to topping.
 - 8.3.1.3. Charging is automatically terminated at the end of the total time selected (cycle end), or as a fault if:
 - Battery overtemperature is detected (Overtemp fault).
 - Battery voltage is in excess of 42/85V (voltage fault).
 - Actual charging current differs from the programmed value (current fault).
 - NOTE: Charge operation may be terminated at any time by depressing the (green) reset button.
- 8.3.2. Stop on Peak Voltage.
 - 8.3.2.1. The battery is charged at the main rate for a preset time.
 - 8.3.2.2. When the battery voltage reaches the programmed peak voltage, the charging current stops.
 - 8.3.2.3. Charging is automatically terminated at the end of the total time selected (cycle end), or as a fault if:
 - Battery overtemperature is detected (Overtemp fault).
 - Battery voltage is in excess of 42/85V (voltage fault).
 - Actual charging current differs from the programmed value (current fault).
 - NOTE: Charge operation may be terminated at any time by depressing the (green) reset button.

8.4 DISCHARGE

NOTE: For battery voltages greater than 32V, the discharge current is automatically limited to 30A. A current fault condition will result if more than 30A is programmed.

8.4.1. ANALYSIS (AUTO CUT-OFF):

- 8.4.1.1. The battery is discharged at the selected rate for a preset time.
- 8.4.1.2. Discharge is automatically terminated (cycle end), at the end of the time selected or if the battery voltage reaches the equivalent of 1 VOLT/cell (capacity failure), as determined by the number of cells programmed, or it is terminated as a fault, if:
 - The actual discharge current differs from the programmed value. (Current Fault).
 - Overheating of the transistor heat sinks is detected (overheat fault).
 - *NOTE: Discharge operation can be terminated at any time by depressing the (green) reset button.*

8.4.2. FULL DISCHARGE:

- 8.4.2.1. The battery is discharged at the selected rate for a preset time.
- 8.4.2.2. Discharge is automatically terminated (cycle end) at the end of the time selected, or as a fault, if:
 - The actual discharge current differs from the programmed value (Current Fault). *NOTE: Undercurrent fault monitoring is disabled at battery voltages below 3V.*
 - Overheating of the transistor heat sinks is detected (overheat fault).

9. OPERATING INSTRUCTIONS

9.1 GENERAL

9.1.1. Connect the Battery

- 9.1.1.1. Connect the battery cable to the batteries and the Temp-Plate.
- 9.1.1.2. If only one battery is used, connect the free plug to the shorted receptacle provided in the Temp-Plate.
- 9.1.1.3. Note: if the equipment is started without shorting the free plug, a Voltage Fault will be generated.
- 9.1.1.4. Observe polarity when using the Single Cell Adaptor.
- 9.1.1.5. If battery polarity is reversed, a voltage fault condition will be indicated and further operation of the instrument will be inhibited.

9.1.2. Verify Voltmeter

- 9.1.2.1. The digital voltmeter will read battery voltage if the selector switch is in the internal position.
- 9.1.2.2. Select the scale consistent with the battery voltage.

9.1.3. Program the number of cells.

- 9.1.3.1. Enter the number of cells of the battery
- 9.1.3.2. When working with more than one battery enter the TOTAL number of cells.
- 9.1.3.3. Note 1: In the Full Discharge mode the number of cells is ignored.
- 9.1.3.4. Note 2: In the Float and Peak voltage modes, the cell selector becomes a nominal battery voltage selector. See the chart in on section [9.7].

9.2 CONSTANT CURRENT CHARGE

- 9.2.1. Voltage Mode
 - 9.2.1.1. Set the Voltage Mode Selector to CC
- 9.2.2. Main Charge
 - 9.2.2.1. Program Main Charging Rate and the time duration.
 - 9.2.2.2. Verify that the Timer Speed is consistent with the required elapsed time.
- 9.2.3. Topping Charge
 - 9.2.3.1. Program Topping charging rate and total time of charge (Total time = Main + Topping Times).
 - 9.2.3.2. Start in Dual Rate
 - 9.2.3.3. Depress the Two Rate (white) control button.
 - 9.2.3.4. DUAL and MAIN indicators will turn on and current will rise to the set rate in about three to five seconds.
 - 9.2.3.5. Verify colon(:)
 - The colon in the digital time display will flash at the rate of one cycle per second.
- 9.2.4. Single Rate Charge
 - 9.2.4.1. For a single rate, program the current using the Topping selector (ignore the Main Current Selector)
 - 9.2.4.2. Set the required Total Time (ignore the Main Time) and depress the single rate (yellow) control button.
 - 9.2.4.3. The SING and TOP indicators will turn on and battery current will rise to the set rate in about three to five seconds.

9.3 CONSTANT VOLTAGE CHARGE

- 9.3.1. Voltage Mode
 - 9.3.1.1. Set the Voltage Mode Selector to CV
- 9.3.2. Nominal Battery Voltage
 - 9.3.2.1. Enter the nominal battery voltage using the cell selector. See the chart in section [9.7].
- 9.3.3. Maximum Charge Current
 - 9.3.3.1. Program the maximum charge current using the Topping Current selector.
- 9.3.4. Time
 - 9.3.4.1. Program sufficient time in the Total Time selector to allow the battery to reach the required charge level (consult battery manufacturers specifications).
 - 9.3.4.2. Verify that the Timer Speed is consistent with the required elapsed time.

9.3.5. RUN

- 9.3.5.1. Start the Charger-Analyzer in the Single Rate mode. The charger will start to reduce the charging current when the battery voltage is within 0.5V of the float level.
- 9.3.5.2. The charge will terminate automatically (CYCLE END) when the TOTAL TIME selected is reached.
- 9.3.5.3. The charge will terminate as a FAULT if the MONITOR CIRCUIT detects that:
 - Battery temperature exceeds 45°C/113°F (BATTERY OVERTEMP FAULT).
 - The actual charge current deviates from the programmed value (CURRENT FAULT) until it reaches de CV voltage.

9.4 Peak Voltage Charge

9.4.1. Voltage Mode

- 9.4.1.1. Select PEAK STOP to stop the charge at the selected peak voltage.

9.4.2. Nominal Battery Voltage

- 9.4.2.1. Enter the nominal battery voltage using the cell selector. See the chart in section [9.7.
- 9.4.2.2. Program the Topping Charge currents as required.
- 9.4.2.3. Program the Total Time selector to allow the battery to reach the required charge level (consult battery manufacturers specifications). Verify that the Timer Speed is consistent with the required elapsed time.
- 9.4.2.4. Start the Charger-Analyzer in the Single Rate mode. The charger will stop when the battery reaches the peak voltage.
- 9.4.2.5. The charge will terminate automatically (CYCLE END) when the TOTAL TIME selected is reached.
- 9.4.2.6. The charge will terminate as a FAULT if the MONITOR CIRCUIT detects that:
 - Battery temperature exceeds 40°C/104°F (BATTERY FAULT).
 - (BATTERY OVERTEMP FAULT).
 - The actual charge current deviates from the selected value (CURRENT FAULT).

9.5 Peak Voltage Transfer

9.5.1 Voltage Mode

- 9.5.1.1. Select PEAK XFR to transfer from Main to Topping at the selected peak voltage.

9.5.2 Nominal Battery Voltage

- 9.5.2.1. Enter the nominal battery voltage using the cell selector. See the chart in section [9.7].
- 9.5.2.2. Program the Main and Topping Charge currents as required.
- 9.5.2.3. Program the Main and Total Time selector to allow the battery to reach the required charge level (consult battery manufacturers specifications). Verify that the Timer Speed is consistent with the required elapsed time.
- 9.5.2.4. Start the Charger-Analyzer in the Dual Rate mode. The charger will transfer from Main to Topping (if the selected voltage is reached).
- 9.5.2.5. The charge will terminate automatically (CYCLE END) when the TOTAL TIME selected is reached.
- 9.5.2.6. The charge will terminate as a FAULT if the PROCESSOR detects that:
 - Battery temperature exceeds 40°C/104°F (BATTERY OVERTEMP FAULT).
 - The actual charge current deviates from the selected value (CURRENT FAULT).

9.6 Discharge

NOTE: Do not place batteries on the Temp-Plate during discharge. Due to the normal heating of the battery a false Overtemp may be generated later during the charge process.

9.6.1. Voltage Mode

- 9.6.1.1. Select CC for AUTO DISCHARGE OR FULL DISCHARGE. Attempting to discharge in other than CC VOLTAGE MODE will generate an error.

9.6.2. Number of Cells

- 9.6.2.1. Enter the number of cells.
- 9.6.2.2. Ignore this step if FULL DISCHARGE is to be selected.

9.6.3. Total Time

- 9.6.3.1. Enter the TOTAL TIME (ignore the Main Time).
- 9.6.3.2. Verify that the Timer Speed is consistent with the required elapsed time.
- 9.6.3.3. Enter the DISCHARGE CURRENT (ignore the Main Current).
- 9.6.3.4. Depress the Blue button for DISCHARGE with automatic cut-off (ANALYSIS), or the Red button for FULL DISCHARGE (DEEP CYCLE).
- 9.6.3.5. DISCHARGE will terminate automatically (CYCLE END) when the (TOTAL) time selected is reached or (CAPACITY FAILURE) if the BATTERY voltage falls below the equivalent of ONE VOLT per CELL prior to the selected time.
- 9.6.3.6. NOTE: Battery voltage is ignored during Full Discharge.
- 9.6.3.7. Discharge will terminate as a FAULT if the PROCESSOR detects:
 - An overheating of the discharge transistors (OVERHEAT FAULT).
 - That the discharge current differs from the programmed value (CURRENT FAULT).
 - That the programmed current exceeds 30A for a battery voltage in excess of 32V.

9.7 Float/Peak Voltage Chart

CHART RELATING THE COMPUTED FLOAT AND PEAK VOLTAGES TO THE SELECTED NOMINAL BATTERY VOLTAGE

9.7.1. The Cell Selector becomes a Nominal Battery Voltage selector in other than the Constant Current settings of the Voltage Mode Selector.

9.7.2. NOTE: Nominal battery voltage is referenced on the basis of 1.2V/cell for Nickel-Cadmium batteries and 2V/cell for Lead-Acid batteries. e.g.: a 20 cell Nickel-Cadmium battery and a 12 cell Lead-Acid battery are both considered to be 24V batteries. Consult manufacturers' specifications for optimum float and peak voltage charge levels.

Table 1 - Constant Voltage and Peak Voltage Chart

CELL SELECTOR	FLOAT VOLTAGE	PEAK VOLTAGE	CELL SELECTOR	FLOAT VOLTAGE	PEAK VOLTAGE
1	-----	-----	25	29.1	30.6
2	2.3	2.5	26	30.3	31.9
3	3.5	3.7	27	31.5	33.1
4	4.7	4.9	28	32.6	34.3
5	5.8	6.1	29	33.8	35.5
6	6.7	7.4	30	35.0	36.8
7	8.2	8.6	31	36.1	38.0
8	9.3	9.8	32	37.3	39.2
9	10.5	11.0	33	38.4	40.4
10	11.7	12.3	34	39.6	41.7
11	12.8	13.5	35	40.8	42.9
12	14.0	14.7	36	41.9	44.1
13	15.1	15.9	37	43.1	45.3
14	16.3	17.2	38	44.3	46.6
15	17.5	18.4	39	45.4	47.8
16	18.6	19.6	40	46.6	49.0
17	19.8	45.3	41	47.8	50.2
18	21.0	22.1	42	48.9	51.5
19	22.1	23.3	43	50.1	52.7
20	23.3	24.5	44	51.3	53.9
21	24.5	25.7	45	52.4	55.1
22	25.6	27.0	46	53.6	56.4
23	26.8	28.2	47	54.8	57.6
24	28.0	29.4	48	55.9	58.8

9.8 STATUS LCD

The internal LCD Display, located behind the Timer, will show error messages and some status information

9.8.1. The first and second lines will show basic status information while the second line will show error messages.

9.8.1.1. First Line Status:

- V: Program Version
- C: Number of Cells
- M: Running Mode

9.8.1.2. Second Line Status:

- B: Backup Battery Voltage (available only when running)
- CV: AC Charge Voltage (available only when running)
- T: Start-up fault testing time delay (12 seconds)

9.8.1.3. Second Line Error Messages and additional status information

9.8.1.3.1. 1- Rev Polarity

- Battery connection with polarity reversal

9.8.1.3.2. 2-ABS OV

- Absolute Overvoltage. Open circuit in the battery or battery connection.

9.8.1.3.3. 3-BATT OV

- Battery Overvoltage.

9.8.1.3.4. 4-LOW AC

- Charge voltage below minimum.

9.8.1.3.5. 5-OPEN LIMITER

- Charge or Discharge Current Limiter is open.

9.8.1.3.6. 6-CHG OVER MAX

- Selected Charge Current above the maximum.

9.8.1.3.7. 7-DISCH OVER MAX

- Selected Discharge Charge Current above the maximum.

9.8.1.3.8. 8-DISCH POWER MAX

- Discharge Power Dissipation above the maximum (Battery Voltage x selected Discharge Current).

9.8.1.3.9. 9-CAP FAIL

- Capacity Failure.

9.8.1.3.10. 10-DISCH LOW BATT

- Battery Voltage below the minimum for discharge.

9.8.1.3.11. 11-TIME ERROR

- Entering an inconsistent time (i.e. 1:60)

- 9.8.1.3.12. 12-BTAS HOLD
 - Operation is on hold by the BTAS program.
- 9.8.1.3.13. 13-N/A
 - N/A
- 9.8.1.3.14. 14-POWER RECOVERY
 - Recovering from a Power Failure.
- 9.8.1.3.15. 15-N/A
 - N/A
- 9.8.1.3.16. 16-INT OVERHEAT
 - Overheating Discharge Banks.
- 9.8.1.3.17. 17-BATT OVERTEMP
 - Battery is too hot.
- 9.8.1.3.18. 18-N/A
 - N/A
- 9.8.1.3.19. 19-SEQUENCE ERR
 - Controls sequence error.
- 9.8.1.3.20. 20-UNDERCURRENT
 - Current is below the selected value.
- 9.8.1.3.21. 21-OVERCURRENT
 - Current is above the selected value.
 -

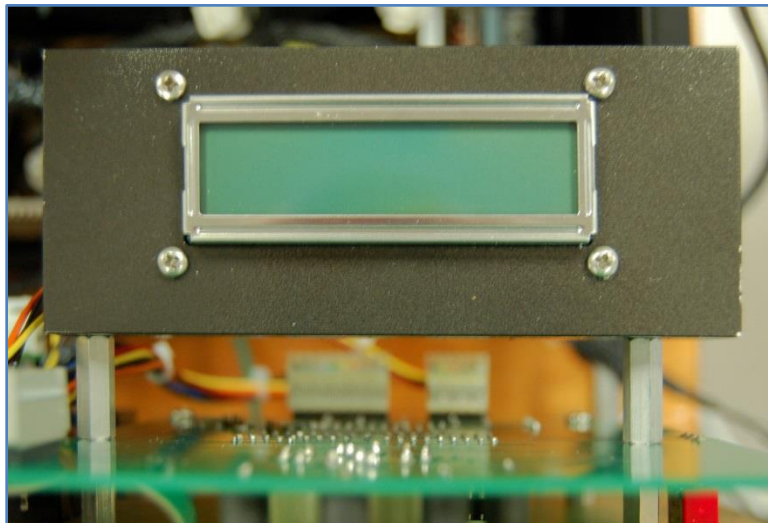

Figure 5 – LCD Readout

9.9 OPERATING NOTES AND PRECAUTIONS

- 9.9.1. Make sure that the instrument is in the reset position before turning power off, or before connecting or disconnecting batteries.
- 9.9.2. When a cycle is terminated either automatically or by resetting, wait about two to three seconds before re-starting in any mode (the Processor has a time delay that ignores switch selections during a 2 to 3 second interval).
- 9.9.3. It is possible to alternate between the two discharge modes or from the dual rate to the single charge rate mode while the unit is in operation, but the charger must be reset before switching to an opposite mode (e.g. from charge to discharge or vice versa).
- *NOTE: The Processor ignores mode change requests without previous resetting of the charger.*
- 9.9.4. Do not exceed a setting of 59 in the Total Time selector.
- If exceeded, the Processor will treat it as 59.
- 9.9.5. If any of the Current Limiters is open, the unit is rendered completely inoperative.
- 9.9.6. It is imperative that the current limiters and fuses be replaced with the same type and value.
- 9.9.6.1. Failure to do so will result in serious damage to the control and power circuitry of the instrument.
- 9.9.6.2. Failure to observe this requirement will void the warranty.
- 9.9.7. Do not block air circulation. A substantial amount of heat must be dissipated, particularly in the discharge mode (up to 1.5KW).
- 9.9.7.1. External heat removal (circulating fan) is required when operating in confined spaces or hot environments.
- 9.9.7.2. Failure to observe this requirement will void the warranty.
- 9.9.8. Do not disconnect the battery cable while the unit is in operation.
- Large current surges can occur, with corresponding arcing, that can damage the charger, the connectors and the battery.
- 9.9.9. Disconnect batteries and power from the instrument (remove the line cord from the wall outlet) before changing circuit boards and current limiters or to perform maintenance or repairs.
- Failure to do so can result in serious (lethal) personal injury and/or serious damage to the instrument.
- 9.9.10. Do not perform battery work on bare metal table tops.
- 9.9.11. Do not attempt to discharge with the Voltage Mode Selector in the CV or any of the PEAK positions.
- The Processor will signal an error.

9.10 Operation with the BTAS16

- 9.10.1. Connect the Control Cable to the C-Scan
- 9.10.2. Connect the Shunt Cable to the S-Scan
- 9.10.3. Associate the Charger to the C-Scan. (see Charger Type and Charger ID in the Main Screen of the BTAS16).
- 9.10.4. Chose to Link the Charger-Analyzer for automatic start-stop control by the BTAS16 or leave unchecked for manual operation.
- 9.10.5. Manual Mode:
 - 9.10.5.1. Program and start the Charger-Analyzer.
 - 9.10.5.2. Allow a few seconds for the current to rise to the final value
 - 9.10.5.3. Start the test in the BTAS16 Main Screen.
- 9.10.6. Automatic Mode:
 - 9.10.6.1. Program and start the Charger-Analyzer (the Charger-Analyzer will be on hold by the BTAS16)
 - 9.10.6.2. Note: the colon will turn ON to indicate being on hold
 - 9.10.6.3. Start the test in the BTAS16 Main Screen.
 - 9.10.6.4. The BTAS16 will start first the Charger-Analyzer and after a few seconds, the data recording will start.

10. INSTALLATION

10.1 BENCH SPACE

- 10.1.1. The Charger-Analyzer system occupies 19" x 17" (48.3 cm x 43.2 cm) of table top space for the charger and 10" x 25" (25 cm X 63.5 cm) for the Temp-Plate.
- 10.1.2. Wight: 68Kg (150 lbs)
- 10.1.3. Allow also at least 6" (15.2 cm) of separation from the wall and adjacent equipment, in order to maintain proper air flow (VITAL!).
- 10.1.4. NOTE 1: In non air-conditioned rooms or if other heat dissipating equipment are nearby, it is recommended that circulating or extracting fans be used to aid in the heated air removal.
- 10.1.5. NOTE 2: Operation in dusty or otherwise "dirty" air environments will severely reduce the cooling capacity of the fans and lead to premature failure.

10.2 LINE VOLTAGE (mains)

- 10.2.1. Wall receptacle: NEMA 6-30R
Provide a dedicated line, 30A minimum, with a motor load type circuit breaker (high turn on inrush).
Note 1: operation with a shared line could result in erratic operation.
Note 2: Operation of this unit with a "soft" line or with a line voltage 10% above or below the nominal 208/230/240VAC will result in erratic operation and may also lead to equipment damage if large voltage surges occur.

- 10.2.2. Line Voltage Settings
See the Power Block Diagram [15]

10.3 Fuses and limiters:

- 10.3.1. Main: 40A Circuit Breaker
- 10.3.2. Charge/Discharge
 - 10.3.2.1. Charge: 60A, Slow, ANL-60
 - 10.3.2.2. Discharge: 80A, fast, ANN-80
- 10.3.3. Power Supplies: 4A, 5mm x 20mm
- 10.3.4. *Warning*

Replacement of fuses and limiters with other types and ratings may result in severe equipment damage and create a fire hazard and will void any applicable warranties.

11. VERIFICATION OF PERFORMANCE

The Charger-Analyzer has been designed, manufactured and tested to give thousands of hours of trouble free operation, but if you find that your unit is not performing properly (or as expected), please refer first to the operating instructions for re-assurance that proper procedures are being followed.

If it is determined then, that the Charger-Analyzer is malfunctioning or appears to be malfunctioning, please refer to the verification of performance, calibration and troubleshooting sections which will show you how to use the various built-in test features to determine or approximate the nature of the problem.

NOTE 1: The Charger-Analyzer is a precision instrument. Use only certified instrumentation capable of accuracies of at least 0.25% on voltage and 0.5% on current.

- The VCM-100 Calibrator for Battery Charger-Analyzers provides all necessary functions to monitor, verify and calibrate the Charger-Analyzer.

NOTE 2: In the following tests make no connection to a battery unless specifically indicated. Always start from reset and always reset at the conclusion of a test.

11.1 REQUIRED TEST EQUIPMENT AND ACCESSORIES

- 11.1.1. VCM-100 Calibrator and one 20 to 50A-Hr, 20 cell battery
- 11.1.2. IF a VCM-100 Calibrator is not available, the following items are required in addition to the battery mentioned in (a) .
 - 11.1.2.1. Power Supply capable of 90V output with very little current capability (less than 25mA).
 - 11.1.2.2. Ammeter or Shunt capable of at least 50A
 - 11.1.2.3. Digital Voltmeter, 3-1/2 digits or better.
 - 11.1.2.4. Four each of 16.5K, 17.5K and 30.1K 1% resistors (1/4W)

11.2 VISUAL VERIFICATION

- 11.2.1. Set the Voltage Mode Selector to CC (first position).
- 11.2.2. Turn power on.
- 11.2.3. Verify the following:
 - 11.2.3.1. Reset/cycle end (green) light must be on
 - 11.2.3.2. The digital panel meters must read zero
 - 11.2.3.3. The elapsed time display must read zero (colon must be off).

11.3 TIMER VERIFICATION

- 11.3.1. Settings:
 - 11.3.1.1. Set the Main and Topping Charge Current Selectors to zero.
 - 11.3.1.2. Set both Time Selectors to zero.
 - 11.3.1.3. Set the Timer Speed Switch to the test (center) position.
- 11.3.2. NOTE: Current and voltage readings must remain at zero during the following tests. If voltage starts to rise, which may lead to voltage a fault, verify that the current selectors are completely at zero.
- 11.3.3. Start the unit by depressing the two rate charge selector.
 - 11.3.3.1. The unit will go immediately into Cycle End.
 - 11.3.3.2. Reset.
- 11.3.4. Set the total time to 01 and start.
 - 11.3.4.1. Unit will start in main charge and immediately transfer to topping, going into cycle end after one second.
 - 11.3.4.2. Reset.
- 11.3.5. Set the main time to 1, total time to 02 and start.
 - 11.3.5.1. The unit will start in the main mode, transfer to topping after one second and go into cycle end after two seconds.
 - 11.3.5.2. Reset.
- 11.3.6. Repeat the above tests, each time advancing the main and total time selectors as follows: 2/04, 4/08, 8/09, 9/10, 9/20, 9/40 and 9/60.

11.4 BATTERY OVERTEMP CUT-OFF

- 11.4.1. Settings:
 - 11.4.1.1. Set current selectors to zero.
 - 11.4.1.2. Set the timer speed switch in the normal position (to the right).
 - 11.4.1.3. Set time selectors to 1/01 and cell selector to 20.
 - 11.4.1.4. Connect the battery cable to the unit but make no battery or Temp-Plate connections. The red Overtemp light will be on.
- 11.4.2. Temp-Plate simulations resistors:
 - 11.4.2.1. Connect to a VCM-100 or
 - 11.4.2.2. Connect one 16.5 K-OHM (1%) resistor between pins D and B
 - 11.4.2.3. Connect one each 30.1 K-OHM (1%) resistors between pins D and C, D and E, and D and H.
 - 11.4.2.4. The red light will turn off.
- 11.4.3. Start in either of the charge modes.
 - 11.4.3.1. The unit will start and immediately go into Overtemp fault (red light flashing and alarm on).
 - 11.4.3.2. Reset.
- 11.4.4. Repeat the previous test by rotating the 16.5 K-OHM resistor in all four positions.
- 11.4.5. Repeat the first test using four 17.5 K-OHM (1%) resistors.
 - 11.4.5.1. The unit must not show Overtemp fault.

11.5 VOLTAGE FAULT TEST

- 11.5.1. Disconnect battery cable from any external devices.
- 11.5.2. Settings:
 - 11.5.2.1. Set the Current Selectors (both) to 010.
 - 11.5.2.2. Set the Time Selectors to 1/01.
 - 11.5.2.3. Set the Cell Selector to 20.
- 11.5.3. Start in either of the charge modes.
 - 11.5.3.1. The unit will start and the output voltage will rise.
 - 11.5.3.2. The unit will stop, indicating a voltage fault.
 - 11.5.3.3. Reset.

11.6 REVERSE POLARITY TEST

- 11.6.1. Connect the battery cable to a voltage source (VCM-100 or low current power supply and reverse the polarity). Start at zero and advance towards -0.5V
- 11.6.2. The unit will show a fault through the alarm and the voltage fault light at about -0.25V (-0.20V to -0.35V).
- 11.6.3. Alternatively, connect the battery cable, with the single cell adaptor, to one cell with the polarity reversed or to a standard 1.5V battery (size is unimportant).

11.7 OVERVOLTAGE CUT-OFF

- 11.7.1. Set the Current selectors to zero and Time selectors to 1/01. Set the Cell selector to 20.
- 11.7.2. Connect the battery cable to an adjustable voltage source (VCM-100 or low current power supply), set to approximately 34V and start the unit in either charge mode.
- 11.7.3. Slowly increase the voltage. Unit will stop and indicate a voltage fault at 35V \pm 0.5V. Reset.
- 11.7.4. See [Figure 7] for adjustments

11.8 DISCHARGE VOLTAGE CUT-OFF

- 11.8.1. Settings:
 - 11.8.1.1. Set the Current selectors to zero and the Time selectors to 1/01.
 - 11.8.1.2. Set the Cell selector to 20.
- 11.8.2. Connect the battery cable to a voltage source (VCM-100 or low current power supply), set to approximately 21V and start the unit in the auto discharge mode (blue).
- 11.8.3. Slowly decrease the voltage. Unit will go into cap fail at 20V \pm 0.3V. Reset.
- 11.8.4. See [Figure 7] for adjustments

11.9 FULL DISCHARGE

- 11.9.1. Settings:
 - 11.9.1.1. Set the Current selectors to zero.
 - 11.9.1.2. Set the Time selectors to 1/01.
 - 11.9.1.3. Set the Cell selector to 20.
- 11.9.2. Start the unit in the full discharge mode (red). Unit will run. Increase the discharge current selector to any value above 1 AMP (010). Unit will continue to run.
- 11.9.3. Switch to Auto discharge. Unit will go to Capacity Failure. Disconnect from the voltage source. Reset.

11.10 CURRENT TRACKING

11.10.1. Settings:

11.10.1.1. Set the Time selectors to 1/01 and the Cell selector consistent with the battery.

11.10.1.2. Set the main charge current selector to 25 AMPS (250)

11.10.1.3. Set the topping charge current selector to 1 AMP (010).

11.10.2. Connect the Battery Cable to the battery.

11.10.3. Start the unit in the two rate mode. Current will rise to $25.0A \pm 0.35A$.

11.10.4. Switch to the single rate mode. Current will drop to $1.0A \pm 0.2A$. Reset.

11.10.5. Repeat this test for other high and low settings.

11.10.6. Repeat also for the discharge mode.

11.10.7. NOTE: In discharge, the readings may be lower by 0.1A to 0.2A (meter characteristic).

11.10.8. See [12.2.3] and [Figure 7] for adjustments

11.10.9.

11.11 VOLTAGE CONTROL

11.11.1. See [Figure 7] for adjustments.

11.12 FLOAT VOLTAGE

- 11.12.1. Settings:
 - 11.12.1.1. Set the Voltage Control Selector to Float
 - 11.12.1.2. Set the Current Selectors to zero.
- 11.12.2. Connect the Battery Cable to the battery and note the battery voltage.
- 11.12.3. Using the chart in [Table 1], [9.7], find in the FLOAT column the closest higher voltage (by at least 1V) to the observed voltage on the battery. Set the cell selector to the value indicated in the Cell Selector column.
- 11.12.4. Start the Charger-Analyzer in Single Rate and advance the Topping current to 1A
- 11.12.5. Observe that the current will start to be reduced as the battery voltage approaches the corresponding float voltage.
- 11.12.6. Example: for 24V measured on the battery, set the cell selector to 22. This will result in a float voltage of 25.6. As long as the voltage at the battery is less than 25.1, the charge current will be as programmed. As the voltage rises towards the expected 25.6, the current will start to decrease and will settle on a value of current to maintain the battery at 25.6
- 11.12.7. Depending on the condition of the battery, a charge current higher than the initial 1A may be required for the battery to rise to the expected float voltage. Conversely, if the voltage rises too fast it will be necessary to select the next higher reading (23 for 26.8V) and /or a lower charge current.
- 11.12.8. Verify that the Charger-Analyzer maintains the battery at the expected voltage $\pm 0.2V$

11.13 PEAK VOLTAGE:

- 11.13.1. Settings:
 - 11.13.1.1. Set the Voltage Control Mode to Peak.
 - 11.13.1.2. Set both current selectors to zero
 - 11.13.1.3. Program for a nominal battery voltage of 24V on the cell selector (setting = 24).
- 11.13.2. Connect the CAL-100 Calibrator or a power supply (capable of producing at least 35V with very little current) in place of the battery.
- 11.13.3. Set the calibrator/power supply to 28.5V
- 11.13.4. Start the Charger-Analyzer in Dual rate. The current will rise to the programmed value.
- 11.13.5. Increase the power supply/calibrator towards 29.4V. The Charger-Analyzer will switch from Main to Topping at a battery voltage of $29.4V \pm 0.5V$.
- 11.13.6. Return the Voltage Control Mode to CC.

11.14 METERS

- 11.14.1. Verify the battery voltage and charge/discharge current readings by comparing against a VCM-100 Calibrator or a reference voltmeter and a reference ammeter (or reference shunt).
- 11.14.2. See [12.2] for adjustments.

12. CALIBRATION

- *NOTE 1: The Charger-Analyzer must be verified (and calibrated if required) at least once every 12 months, or earlier if deviation from performance is observed. (see first note on section 7).*
- *NOTE 2: Perform adjustments only when changing parts and components that require re-calibration.*
- *NOTE 3: Perform a Verification of Performance prior to attempting a calibration (see Section 7, page 25). If the Charger-Analyzer does not perform in accordance to what is called for in Verification of Performance, then, and only then, proceed with an actual calibration (adjustments).*

12.1 CIRCUIT BOARD ADJUSTMENTS AND CALIBRATION

WARNING! Observe caution when working in the vicinity of power supplies and other sources of voltages.

NOTE: Most adjustments are performed with no current (no battery required) and require the use of a voltage source to simulate battery voltages such as the VCM-100 Calibrator or a Power Supply. A battery is required only for the adjustments of current.

12.2 DIGITAL METERS (see [Figure 6]).

NOTE: Digital meters are adjusted by means of multi-turn trimming potentiometers located on the rear (solder side) of the METERS board.

12.2.1. AMMETER

12.2.1.1. SCALE:

- This meter has a full scale of 199.9 millivolts to read a 100 AMP shunt with an output of one millivolt per AMP.
- Verify and calibrate using an external ammeter with digital readout. Adjust R7 at a minimum of 25.0A for a reading within $\pm 0.1A$ of the reference ammeter.
- Insert an external shunt/ammeter in series with any of the battery leads (Use the Single Cell adaptor to facilitate the connection or simply use the VCM-100 which is a calibrator designed specifically to test and certify Charger-Analyzer Battery Charger-Analyzers.
- The charge output current wave is in the form of short pulses (at twice the line frequency). The use of clamp-on meters and moving magnet meters will yield erroneous readings. Verify in discharge (pure DC) if better meters are not available.

12.2.2. VOLTMETER

12.2.2.1. SCALE:

- This meter has a full scale of 1.999 volts, but an attenuator on the board converts it to a full scale of 1.999, 19.99 or 199.9 volts, as selected by the DPM selector switch.

- Verify and calibrate using a voltage source (Power Supply or VCM-100, as a battery voltage simulator) between 10 and 20 volts in the "EXTERNAL 20V" position.
- Adjust R20 for a reading within " 0.1V of the reference voltmeter.
- *NOTE: individual scales cannot be adjusted.*

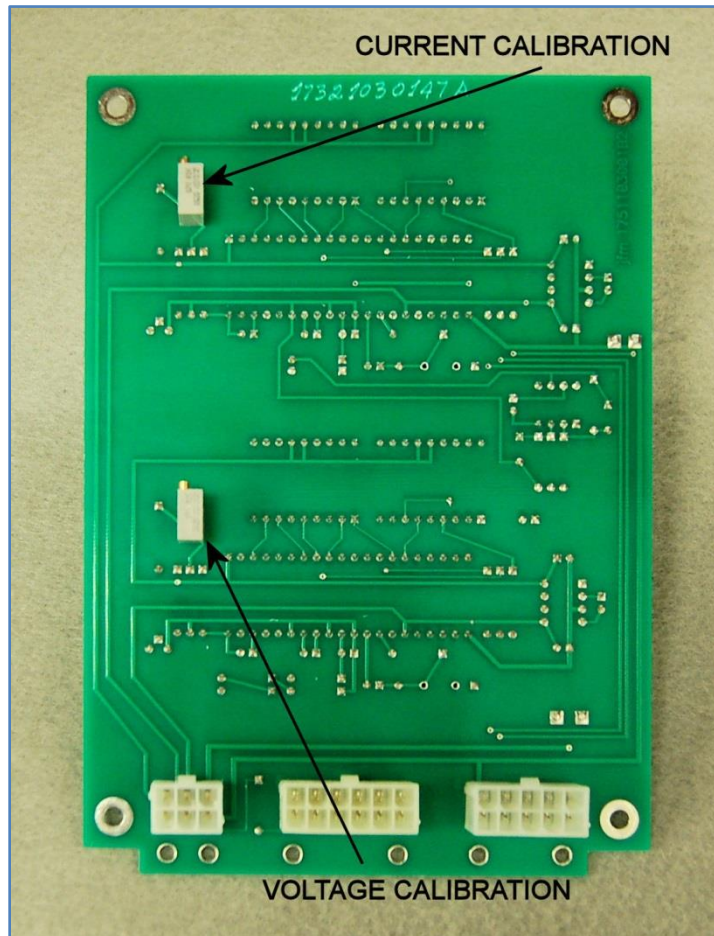

Figure 6 - Meters Board Adjustments (rear view)

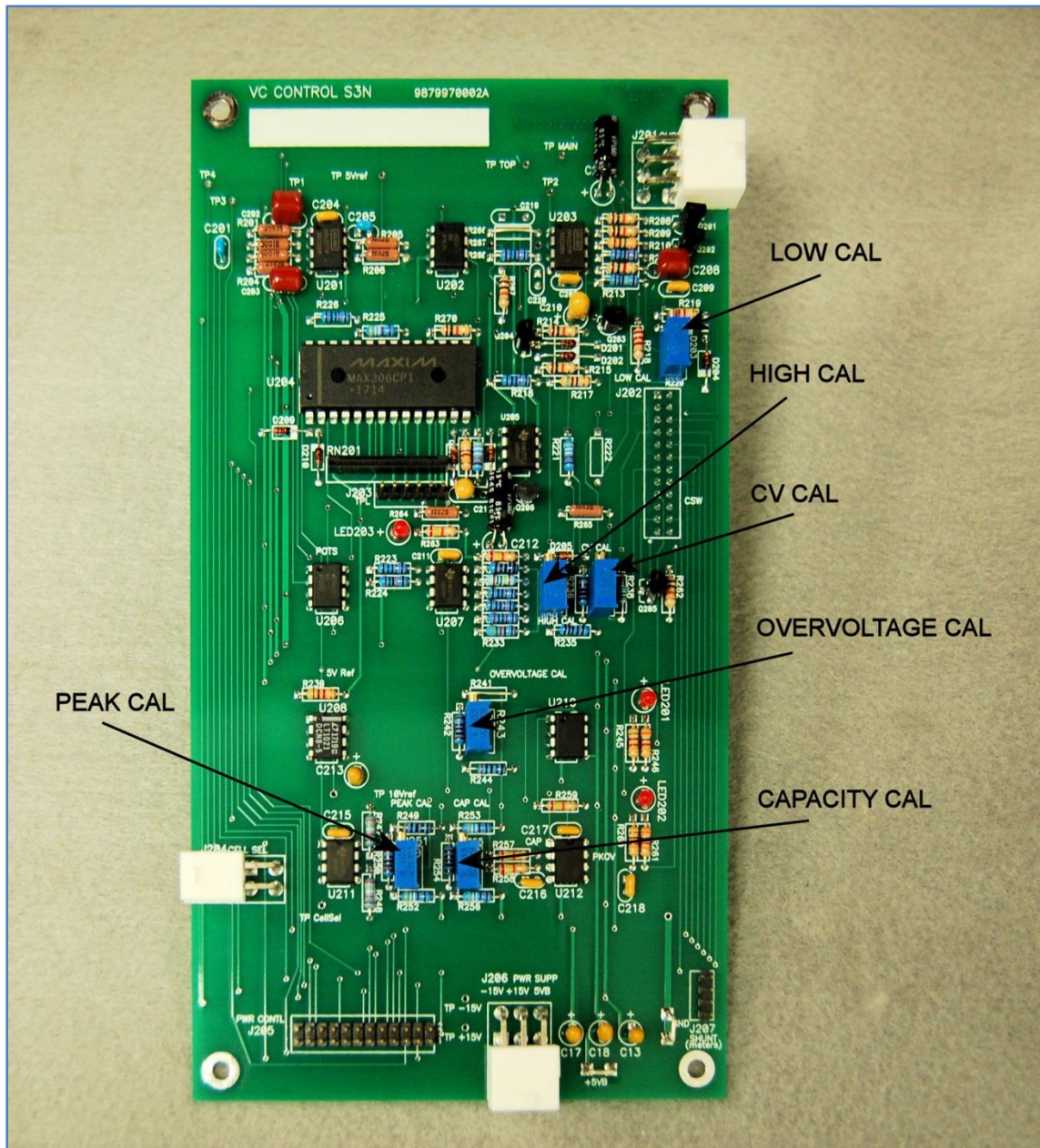

Figure 7 – Voltage/Current Control Board Adjustments

12.2.3. VOLTAGE/CURRENT CONTROL. See [Figure 7].

NOTE: For voltage measurements use the GND hook on the bottom right hand corner of the board as reference common.

12.2.3.1. CURRENT CONTROL

NOTE: Use the hook as ground reference for voltage measurements.

12.2.3.1.1. R220 - LOW CURRENT CALIBRATE.

- Connect a battery and start the Charger-Analyzer in Single Rate.
- Adjust for a reading of 0.9 to 1.0 AMP at the current digital panel meter, with the topping charge current potentiometer set for 1 AMP (010).

12.2.3.1.2. R234 - HIGH CURRENT CALIBRATE

- Connect a battery and start the Charger-Analyzer in Dual Rate.
- Adjust for a reading of 25.0 AMPS at the current digital panel meter, with the main current potentiometer set for 25.0 AMPS (250).
- *NOTE 1: Other currents can also be used for High Current calibration (20A minimum).*
- *NOTE 2: Adjustments of R220 and R234 are interactive. Therefore, it may be necessary to repeat the adjustments once or twice to achieve exact results.*
- The Voltage reading at pin 1 of U201 (shunt amplifier output) must correspond to the current as follows: $0.05\text{V/A} \pm 1\%$.
- Examples:
 - 60 A equals 3.000V
 - 20 A equals 1.000V
 - 10 A equals 0.500V

12.2.3.2. R237 – CONSTANT VOLTAGE CHARGE CALIBRATE.

- For a 24V battery, set the Cell Selector at 24 and start in Single Rate at about 10A or higher depending on the state of charge of the battery.
- Note that the charge current will begin to be reduced at about 27V.
- Adjust R237 for the battery voltage to settle at $28\text{V} \pm 0.5\text{V}$

12.2.3.3. R243 – OVERVOLTAGE CALIBRATE.

- No battery is required for this test.
- Set the Main and Topping Currents to zero.
- Set the Cell Selector at 20 and connect a voltage source (VCM-100) set to approximately 30V and start the Charger-Analyzer in Single Rate (Topping).
- Raise the voltage towards 36V and adjust R243 for an OVERVOLTAGE at $35\text{V} \pm 0.5\text{V}$.

12.2.3.4. R251 – PEAK VOLTAGE CALIBRATE.

- No battery is required for this test.
- Set the Main and Topping Currents to zero.
- Set the Cell Selector at 24 and connect a voltage source (VCM-100) set to approximately 28V and start the Charger-Analyzer in Single Rate (Topping).
- Raise the voltage towards 30V and adjust R251 for a stop on Peak at $29.4\text{V} \pm 0.3\text{V}$.

12.2.3.5. R253 – CAPACITY TEST CUT-OFF CALIBRATE.

- No battery is required for this test.
- Set the Main and Topping Currents to zero.

- Set the Cell Selector at 20 and connect a voltage source (VCM-100) set to approximately 21V and start the Charger-Analyzer in Auto (Capacity) Topping).
- Lower the voltage towards 19V and adjust R253 for a stop on Capacity Failure at $19.9V \pm 0.1V$.

13. TROUBLESHOOTING AND REPAIRS

13.1 TROUBLESHOOTING

The following are hints and directions to help you locate the most probable causes of deviation of performance as established in the procedures of section 8.

- 13.1.1. CHARGES ON MAIN BUT DOES NOT CHARGE ON TOPPING AND DOES NOT DISCHARGE.
Defective Topping/Discharge current selector or defective Voltage/Current Control board.
- 13.1.2. CHARGES PROPERLY ONE BATTERY BUT CANNOT CHARGE TWO BATTERIES AT HIGH RATES.
Low line voltage.
- 13.1.3. GOES INTO VOLTAGE FAULT IMMEDIATELY OR SHORTLY AFTER STARTING UP (charge mode).
Open link or one or more cells developing a high voltage.
- 13.1.4. DISCHARGES CORRECTLY ONE BATTERY BUT RESULTS IN A CURRENT FAULT WHEN DISCHARGING TWO BATTERIES.
Attempting to discharge more than 30A on a battery with more than 28V
- 13.1.5. UNIT CHARGES LOW CURRENT (BELOW 10 AMPS) PROPERLY BUT HUMS NOTICEABLY AT HIGHER CURRENTS.
One of the SCR's is inoperative, or one of the rectifiers is open.
- 13.1.6. CHARGES ON TOPPING AND DISCHARGES CORRECTLY BUT WILL NOT CHARGE IN MAIN.
Defective Main Current Selector or defective Voltage/Current Control Board.
- 13.1.7. STARTS IN THE DISCHARGE MODE BUT GOES INTO CAPACITY FAILURE IMMEDIATELY.
Battery not properly connected. Open link. Open cable.
- 13.1.8. THE DISCHARGE CURRENT LIMITER OPENS THE MOMENT A BATTERY IS CONNECTED TO THE CHARGER.
Shorted discharge transistors(s).
- 13.1.9. BURNED RESISTOR(S) IN THE DISCHARGE HEATSINK(S).
Transistor(s) shorted and discharge current limiter did not open (wrong limiter value or type).
- 13.1.10. DIGITAL VOLTMETER REGISTERS A VOLTAGE (APPROXIMATELY 36 VOLTS) WITH THE UNIT IN RESET AND THE BATTERY IS NOT CONNECTED.
One or both SCR'S shorted.
Do not connect a battery under this condition! (it will open the discharge limiter).
- 13.1.11. CURRENT TRACKING IS OFF BY A SMALL CONSTANT AMOUNT.
Low current calibrate out of adjustment.
- 13.1.12. CURRENT TRACKING IS OFF BY A SMALL AMOUNT WHICH INCREASES AS THE PROGRAMMED VALUE IS INCREASED.
High current calibrate out of adjustment.

- 13.1.13. STARTS BUT EXHIBITS A CURRENT FAULT AFTER SOME TIME (from a few seconds to a few minutes).
- a) Current tracking is off: Verify Control board calibration. See 8.2.5 and 8.2.2.
 - b) Current tracking is proper: Verify that the shunt amplifier in the Voltage/Current Control board reads properly. See 8.2.5 and 8.2.2.
- 13.1.14. VOLTMETER DOES NOT TURN ON.
Open connection to or defective auxiliary 5V supply.
- 13.1.15. OPEN LIMITER, SMALL CRACK.
Inconsequential opening. Replace and resume operation.
- 13.1.16. OPEN LIMITER, BLOWN ELEMENT (vaporized).
- Discharge transistors short.
 - Perform test per 9.2.
- 13.1.17. CURRENT FAULT IN CV.
- Attempting to charge a battery with a voltage higher than the programmed float voltage.
 - Attempting to discharge a battery with a voltage lower than the float voltage.
- 13.1.18. VOLTAGE FAULT IN CV OR PEAK.
Attempting to discharge a battery with a voltage greater than the float voltage.
- 13.1.19. IMMEDIATE TRANSFER TO TOPPING IN PEAK.
Attempting to charge a battery with a voltage higher than the programmed peak voltage.
- 13.1.20. IMMEDIATE STOPPING IN PEAK.
Attempting to charge a battery with a voltage higher than the programmed peak voltage.

13.2 FINDING A SHORTED DISCHARGE TRANSISTOR

Since all discharge transistors are wired in parallel, a single shorted transistor will short the entire bank.

The procedure that follows will allow the finding of the shorted transistor without requiring removal and testing of each device individually.

13.2.1. EQUIPMENT REQUIRED

- Digital Voltmeter.
- Battery, 24V.
- Lamp, 24V (lamp must draw at least 0.5 A).

13.2.2. PROCEDURE

13.2.2.1. TURN UNIT OFF, DISCONNECT IT FROM THE WALL OUTLET.

13.2.2.2. Connect the lamp in place of the discharge current limiter (see fig 8).

13.2.2.3. Connect the charger to the battery.

13.2.2.4. If the lamp illuminates, it indicates that there is a short in the discharge circuit, generated by one or more shorted transistors.

13.2.2.5. Measure the voltage across the individual .22 OHM emitter resistors (RED-RED-GOLD-GOLD) (see fig 8).

- A non zero reading, approximately 0.1V for a lamp drawing .5A, indicates current flow due to a transistor with a collector to emitter short.
- NOTE: A non zero reading on all emitter resistors (0.02V approx for a lamp drawing 0.5A) indicates a different failure mode (collector to base short; refer to step 7).

13.2.2.6. Remove any shorted transistors and repeat steps 4 and 5 until a no short reading is obtained. Replace defective devices only with transistor type MJ15023.

13.2.2.7. If all transistors appear to be shorted (ALL emitter resistors reading a voltage), then, one or more have failed with a collector to base short, causing the remainder of the transistors to turn on. It will then be necessary to check each transistor individually.

- This can be greatly facilitated by searching for a zero reading. This will indicate the shorted device.

13.2.2.8. When replacing transistors, make sure that the base and emitter pins engage properly in the socket contacts. Add heat sink compound and torque the screws properly to insure a good thermal transfer.

- NOTE: If replacing any of the control transistors (Q1 and Q2), note that they are mounted with a mica insulator.

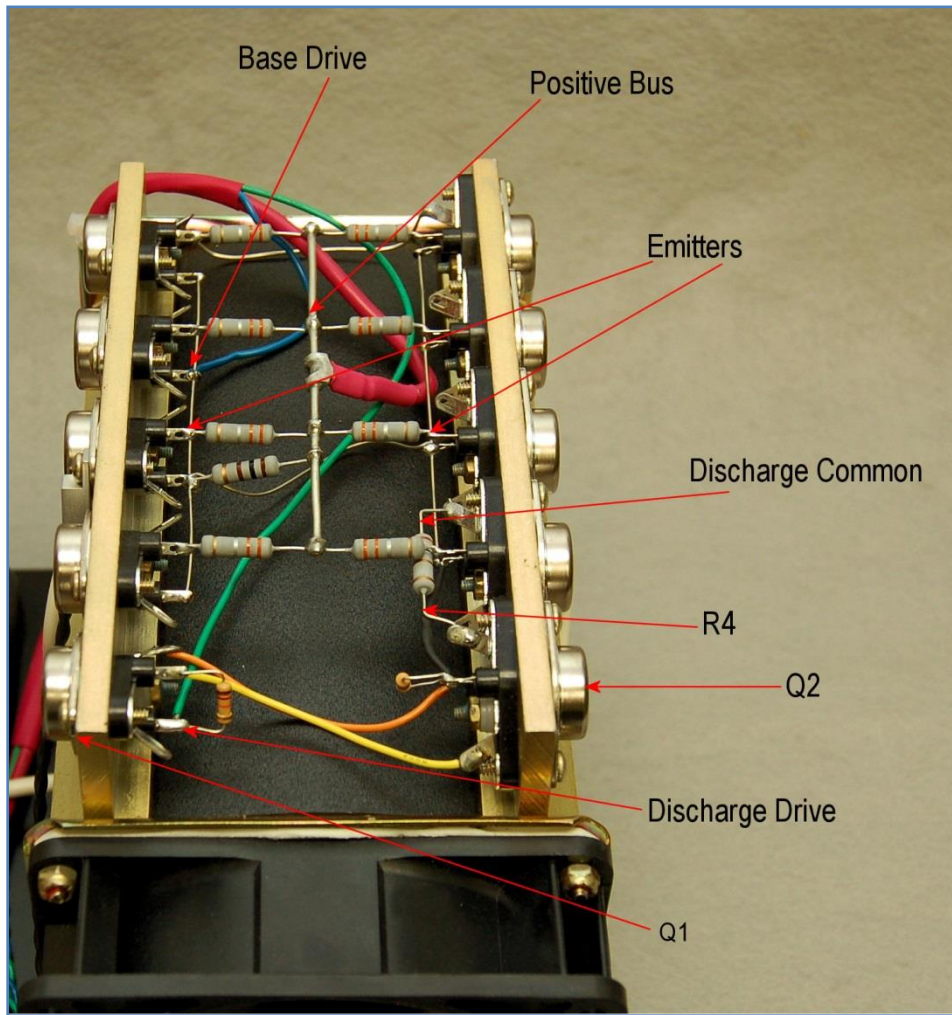

Figure 8 - Measuring for a shorted transistor

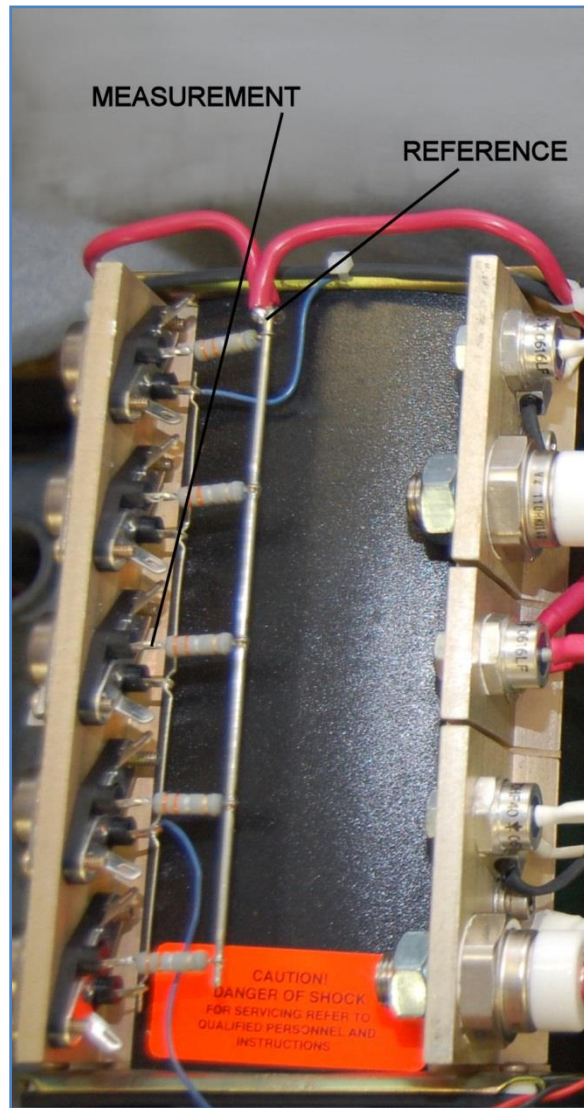

Figure 9 - Measuring for a shorted transistor

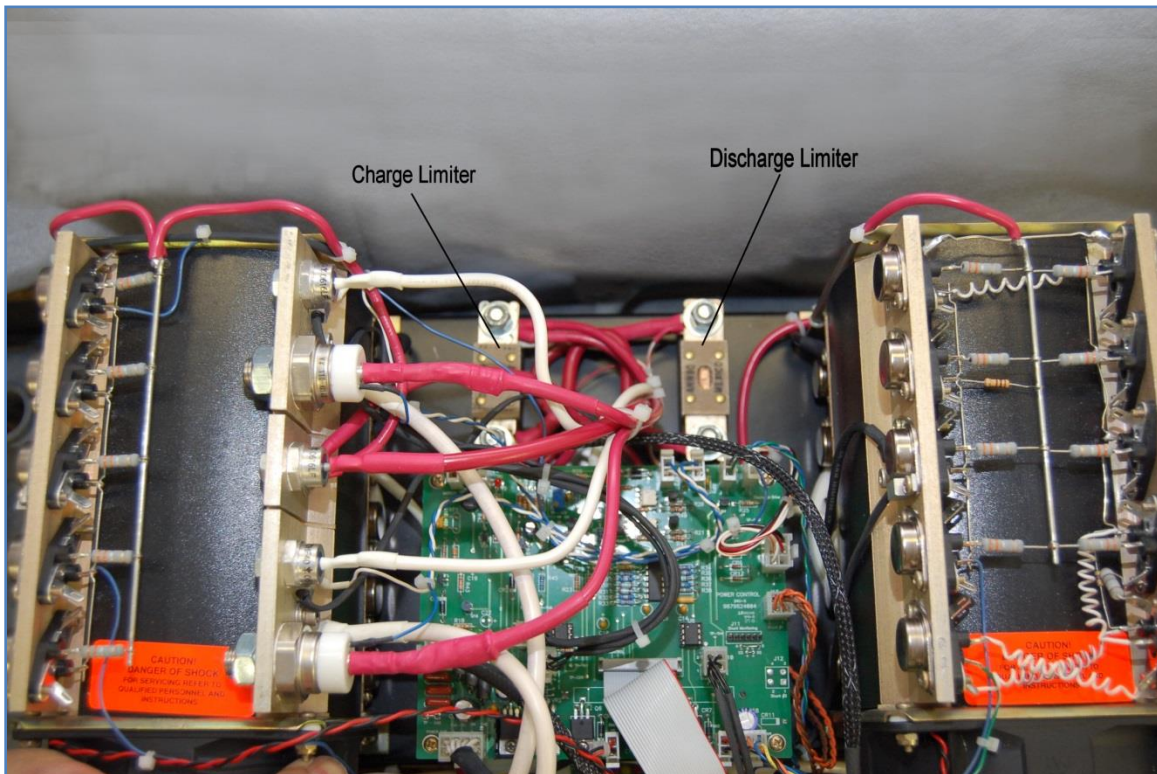

Figure 10 - Location of Current Limiters

14. INSTALLATION

14.1 BENCH SPACE

- 14.1.1. Footprint: 19 inches (38.3 cm) wide x 14 inches (35.6 cm) deep
- 14.1.2. Height: 14 inches (35.6 cm)
- 14.1.3. Clearance: 6 inches (15.2 cm) all around
 - Note: allow for dissipation of air during discharge (use a small fan to help move out the hot air).
- 14.1.4. Weight: 68 Kg (150 lbs)

14.2 LINE VOLTAGE (mains)

- 14.2.1. Wall receptacle: NEMA 630R
 - Provide a dedicated line, 30A minimum, with a motor load type circuit breaker (high turn on inrush).
 - Note: operation with a shared line could result in erratic operation
- 14.2.2. Line Voltage Setting
 - 14.2.2.1. See the Power Block Diagram [Figure 19].
 - 14.2.2.2. Select the Line Voltage per the Transformers Wiring Block – See [Error! Reference source not found.], [Error! Reference source not found.], [Error! Reference source not found.], and [Error! Reference source not found.].
 - 14.2.2.3. Note:
 - 14.2.2.3.1. Earlier units used dual primary transformers. Refer to inserts for detailed information.

14.3 FUSES AND LIMITERS:

- 14.3.1. Main: 40A Circuit Breaker
- 14.3.2. Charge/Discharge – see [Figure 10]
 - 14.3.2.1. Charge: 60A, Slow, ANL-60
 - 14.3.2.2. Discharge: 80A, fast, ANN-80
- 14.3.3. Power Supply: 4A, 5mm x 20mm
- 14.3.4. Warning
 - Replacement of fuses and limiters with other types and ratings may result in severe equipment damage and create a fire hazard and will void any applicable warranties.

15. LINE VOLTAGE (MAINS)

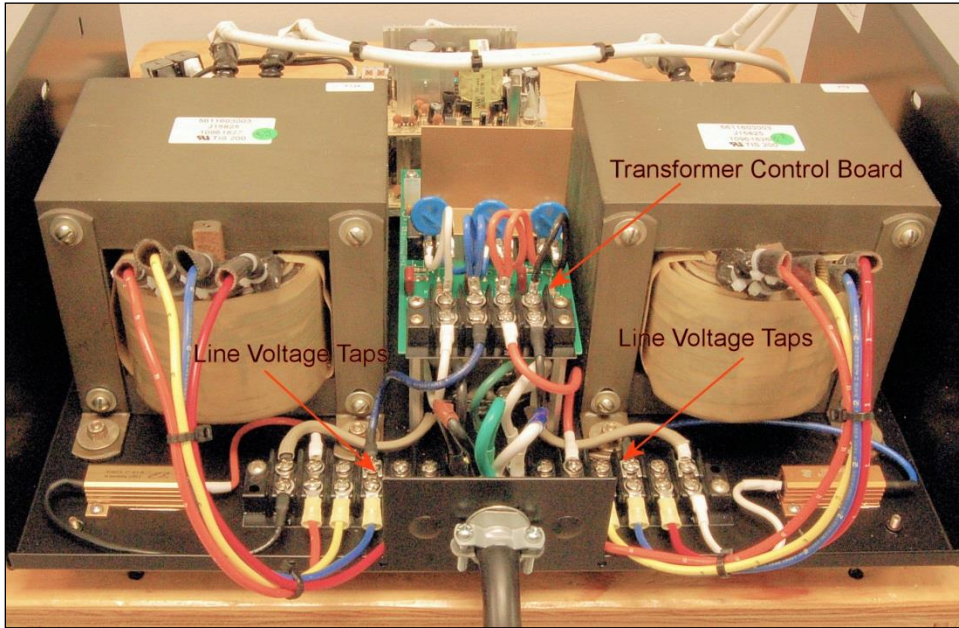

Figure 11 – Chassis Line Voltage Input

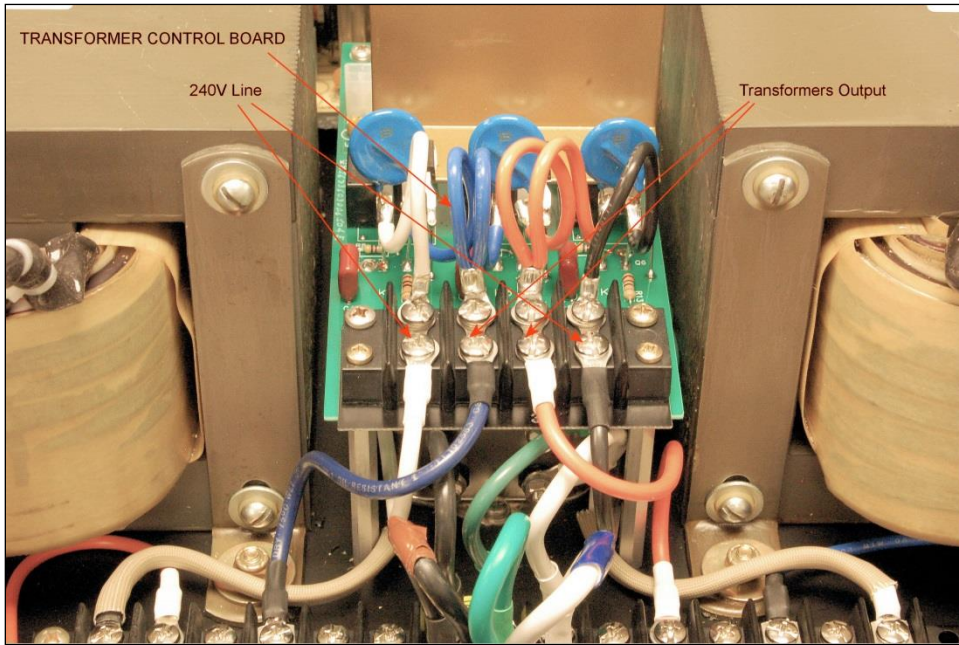

Figure 12 – Transformer Control Wiring

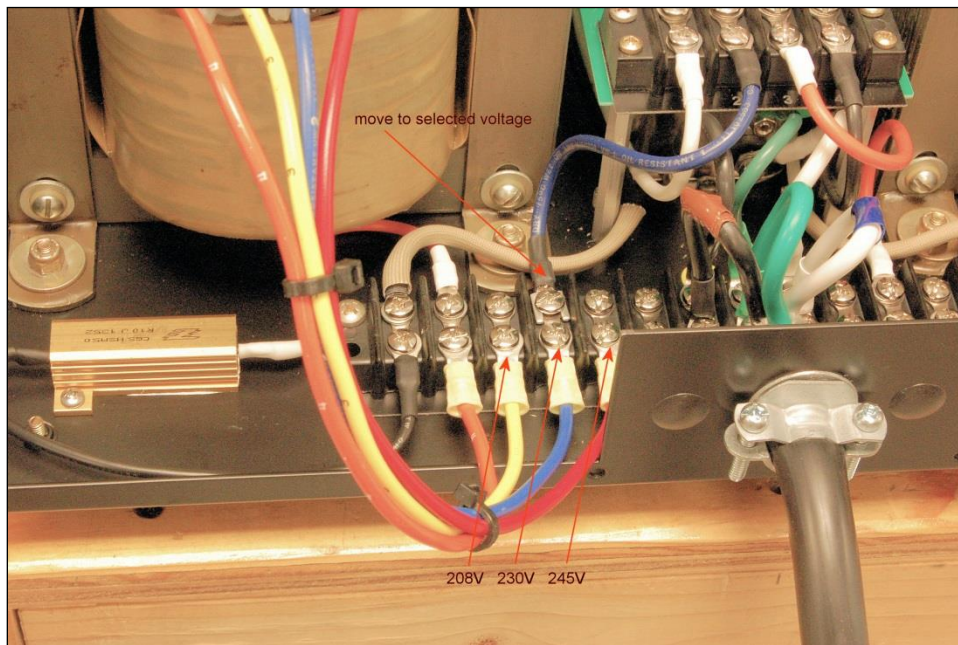

Figure 13 - Line Voltage Wiring, left side

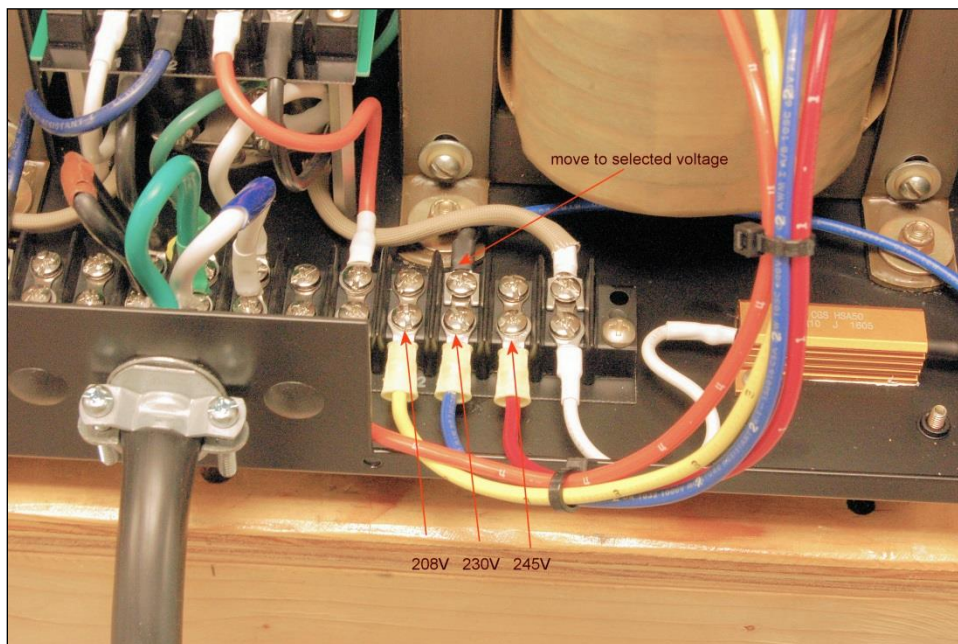

Figure 14 - Line Voltage Wiring, right side

16. POWER BLOCK DIAGRAM

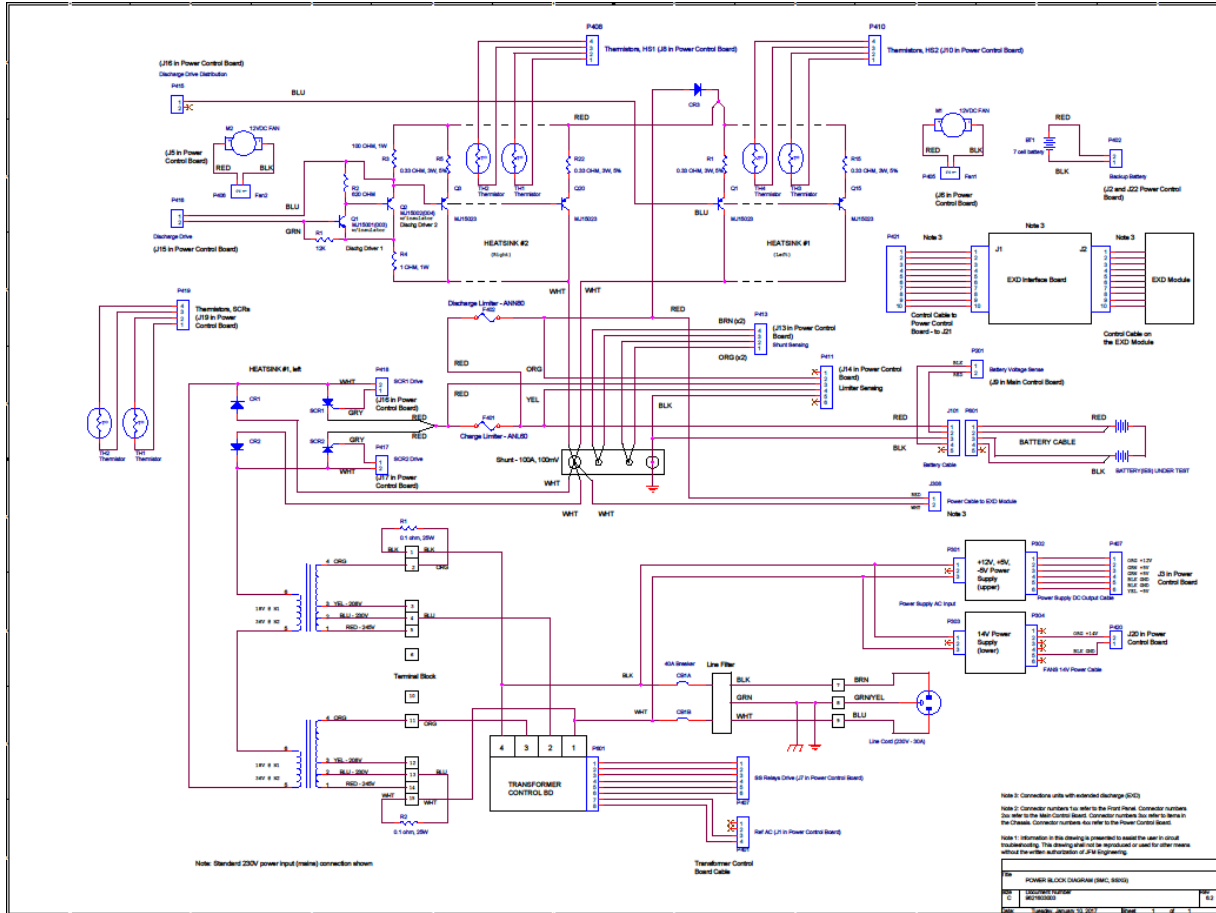

Figure 15 – Power Diagram

17. REPLACEABLE MODULES AND PARTS

17.1 CIRCUIT BOARDS

9879103001 - METERS
9879970001 – PROCESSOR CONTROL
9879970002 – VOLTAGE/CURRENT CONTROL
9879970003 – TIMER
9879603004 – POWER CONTROL
9879603006 – TRANSFORMER CONTROL

17.2 PARTS

30110003M0 – INSULATOR, MICA, TO-3
391207R110 – BATTERY, RECHARGEABLE, 7 cells, 700mA-Hr
40226513R5 – FANS POWER SUPPLY
4022PT65A0 – MAIN POWER SUPPLY
4022PS0505 – Voltmeter 5V POWER SUPPLY
4317ANL060 – CURRENT LIMITER, ANL-60
4317ANN080 – CURRENT LIMITER, ANN-80
47412D1R00 – RESISTOR, POWER, 1 ohm, 2W, 5%
47130E10R0 – RESISTOR, POWER, 10 ohm, 1W, 5%
474120F1010 – RESISTOR, POWER, 100 ohm, 1/2W, 5%
47413CR33F – RESISTOR, POWER, 0.33 ohm, 3W, 5%, flameproof
4755101031 – POTENTIOMETER with DIAL, 10 turn
47562H1030 – CELL SELECTOR
4822J15001 – POWER TRANSISTOR, MJ15001
4822J15002 – POWER TRANSISTOR, MJ15002
4822J15023 – POWER TRANSISTOR, MJ15023
51441B2061 – MAIN TIME SELECTOR
51442B2061 – TOTAL TIME SELECTOR
9811960461 – CHARGE SCR
9811960463 – CHARGE DIODE
9811960462 – DISCHARGE DIODE
9861603001 – POWER SUPPLY CABLE
9861603002 – POWER FEED CABLE
9861603004 – TRANSFORMER CONTROL CABLE
9895960803 – BATTERY CABLE

17.3 TEST EQUIPMENT

9891064004 - VCM-100, Calibrator for Charger-Analyzers

17.4 OTHER

Contact the factory at:
TEL 305-592-2272, TEL 305-599-6893
FAX 305-594-4933
www.jfmeng.com

18. BATTERY TESTING NOTES

Note, hazardous condition: Handle batteries with extreme care as they are capable of very high discharge rates if short circuited.

Check the Battery Manual, CMM or Aircraft Manufacturer Instructions for information on charging, discharging and testing.

The Charge & Float and the Charge & Peak Stop modes are particularly useful with lead acid batteries, where the battery voltage is a better indicator of the state of charge, as compared with Nickel-Cadmium batteries where terminal voltage gives little information on the state of charge.

Lead-Acid batteries are normally float charged (constant voltage) typically at 2.3V/cell. A 6 cell pack (12V) will then be float charged with the voltage selector at 13.8V. In this mode, the charge current is set to the highest level that the cells will safely take (typically up to 1C depending on the battery type and specific manufacturer instructions). This will be the charge current until the float voltage is reached, at which time the current will diminish to the level needed to maintain the float voltage.

Lead-Acid batteries can also be charged in a manner in which it is possible to know much better the end of charge. When a Lead-Acid cell is charged with constant current at C/15 to C/10, the end voltage will rise rapidly at about 90 to 95% of charge, which occurs at about 2.4 to 2.45V/cell. A 5A-hr, 6 cell pack, can be charged at 335mA to 500mA, with the voltage selector at 14.7V. The CHARGER-ANALYZER will stop the charge operation when the rapid rise of end-of-charge voltage is detected.

For Nickel-Cadmium batteries, the most effective charge method is constant current vs time. In the absence of any particular instructions from the manufacturer, charging at c/10 for 12 to 16 hours will insure a complete charge.

The Nickel-Cadmium batteries can also be charged in the float mode, with a voltage of 1.4 V/cell (a 20 cell battery would be set to 28.0V).

NOTE: Prolonged use of the float (constant voltage) method on Nickel-Cadmium batteries will result in cell imbalance, which could eventually lead to premature cell failure due to un-even charge acceptance and un-even discharge capacity.

19. GLOSSARY

- **Battery Manual:** General Technical information provided by a manufacturer applicable to a series of batteries.
- **Battery Test Profile:** A specific group of parameters for a specific type of test (e.g., Time, Current and Voltage for a Capacity Test).
- **BTAS16:** A computerized Battery Test System
- **Capacity Test:** Test performed to determine if a battery can deliver the advertised, specified or required amount of current.
- **CMM:** Technical information provided by a manufacturer for a specific battery (Component Maintenance Manual)
- **CPU:** Central Processor Unit that under program control, processes commands to govern and monitor the operation of the instrument
- **C-SCAN:** A Data Acquisition Terminal (part of the BTAS16)
- **Deep Cycle:** As applicable to Nickel-Cadmium batteries, the process of discharge to zero for each of the cells (to equalize the cells).
- **Electrolyte Level Test:** As applied to Nickel-Cadmium cells that have a vent cap, the process of verifying the level of the electrolyte and the addition of distilled water as required (Note that this test is performed only at the end of a charge cycle).
- **Full Discharge:** Constant Current Discharge with no voltage limit (discharge to 0V).
- **Lead-Acid:** Chemistry system of batteries used for most stand-by applications and for applications demanding less severe discharge currents (as compared with Nickel-Cadmium).
- **Main Charge:** As applicable to Nickel-Cadmium batteries, the C/2 charge current that provides 100% of the A-hr rating
- **Nickel-Cadmium:** Chemistry system of batteries as used in aviation and other heavy duty applications.
- **Non-Volatile Memory:** Memory area in the microprocessor where certain options can be stored that will remain even if the power is turned off.
- **Overhaul:** The process of disassembly of all interconnections, cleaning/replacement of interconnecting hardware, removal of cells and cleaning of cells and the interior of the battery. As applied to batteries that are made up from an interconnection of multiple cells.
- **SLA:** Sealed Lead-Acid Battery
- **Temp-Plate:** A plate used to measure the temperature of batteries under test
- **Thermal Runaway:** Destructive condition under constant voltage charging where one cell fails and heats up and causes all other cells to fail by transmission of heat from one cell to the next. The drop in internal voltage causes an increase in charge current that intensifies the heating, thus accelerating the process.
- **Topping Charge:** As applicable to Nickel-Cadmium batteries, the C/10 charge current that provides 40% of the A-Hr rating (after the Main Charge)
- **VRLA:** Valve Regulated Lead-Acid Battery

20. DISCLAIMER

20.1 Applicability

- This Charger-Analyzer is a precision instrument intended to be operated by personnel qualified in the servicing of aircraft, industrial or medical batteries.

20.2 JFM Engineering's responsibility

- JFM Engineering's responsibility is limited to the repair/replacement of any malfunctioning part of the system (not responsible for any losses incurred from the usage of the system).

20.3 User's Responsibility

- It is the user's responsibility to verify suitability in the intended application.
- It is the user's responsibility to verify the performance of the instruments and to operate and maintain it in accordance with the above given instructions.
- It is the user's responsibility to test batteries in accordance to the instructions and recommendations of the manufacturers of the batteries.
- It is the user's responsibility to operate the Instrument within standard safety procedures applicable to the operation of a Battery Test Facility.
- It is the user's responsibility to install power receptacles and wiring in accordance with local wiring codes.
- It is the user's responsibility to observe all necessary precautions and to be equipped with personal protective equipment when working with batteries to avoid injury due to electrolyte splashing, short circuits with tools and to avoid injury due to the size and weight of the batteries.
- It is the user's responsibility to verify the integrity of the performance of this instrument in accordance with the instructions of Section 8.
- It is the user's responsibility to operate this instrument within the limits and guidelines as described in the Precautions and Installation sections 6.7 and 7.0
- It is the user's responsibility to properly package the instrument for shipping whenever factory service is required.

21. REVISION INDEX

Table 2 - Index of Revisions

REVISION	DATE	NOTES
1.0	27 September 2017	First Release

Blank Page

Blank Page